

21

2 2





21 3 31

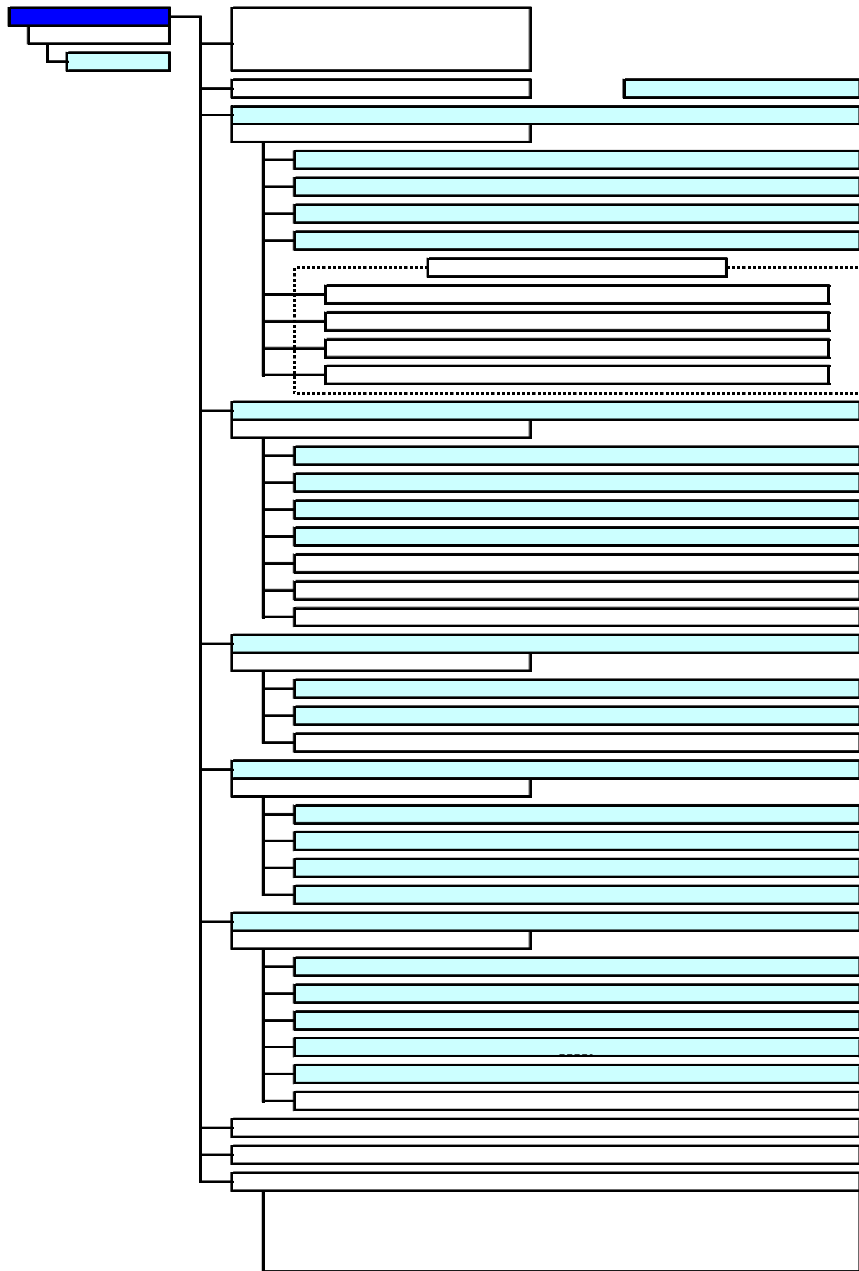

22 3 31

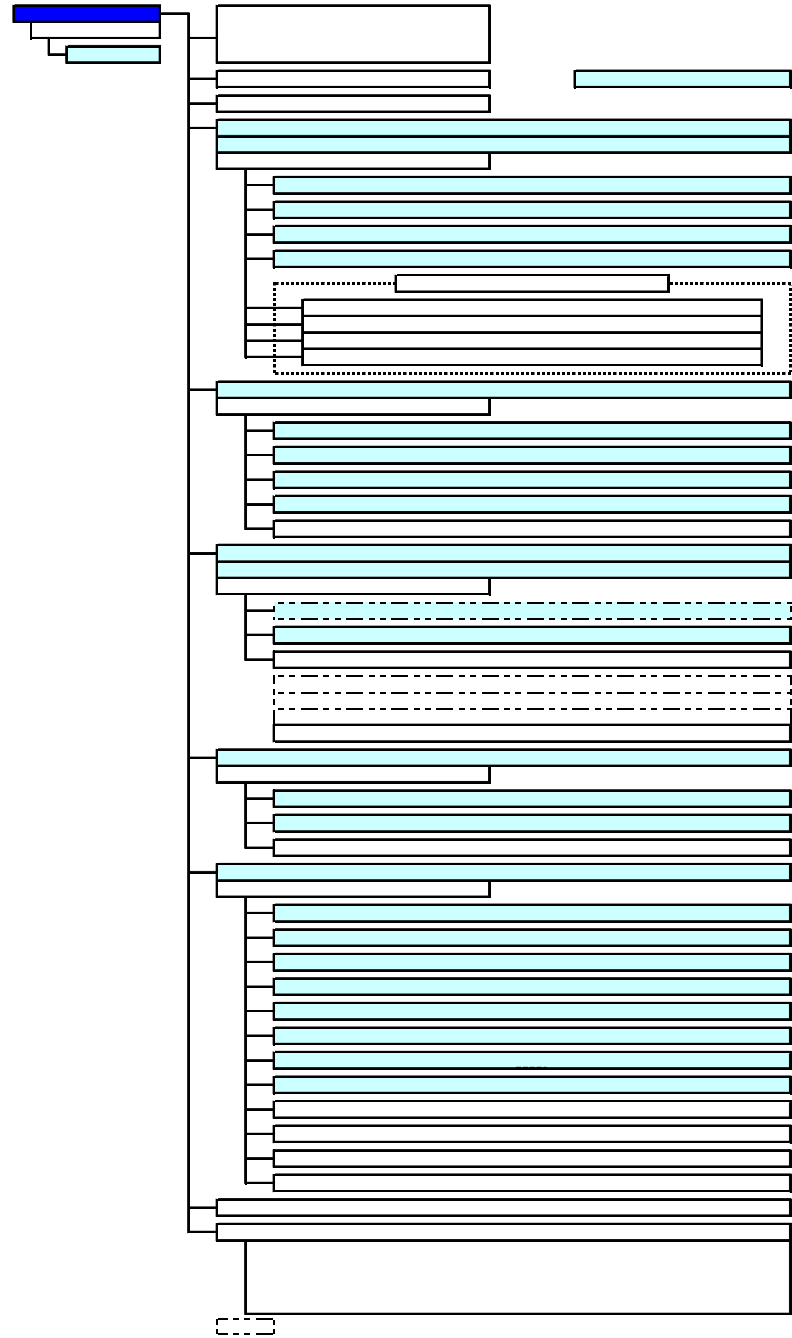

21 3 31

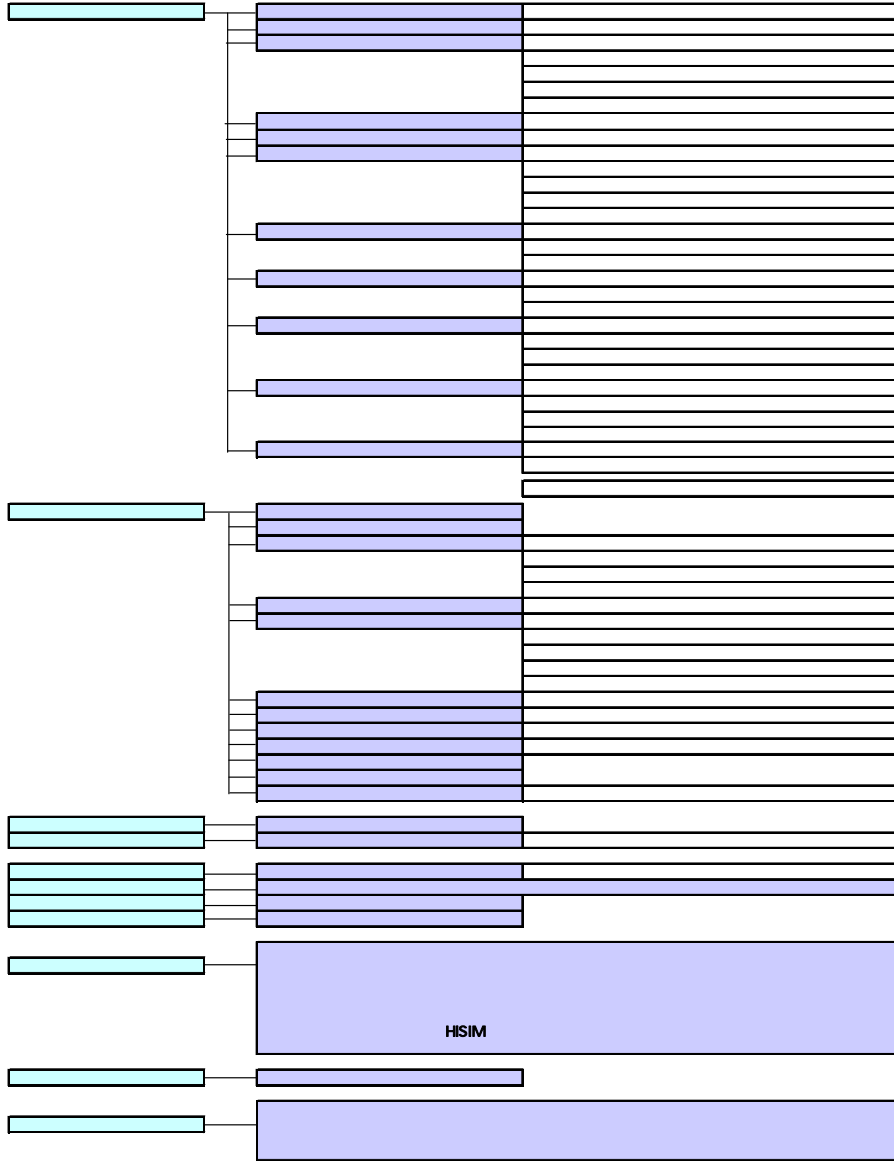

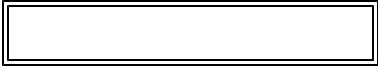

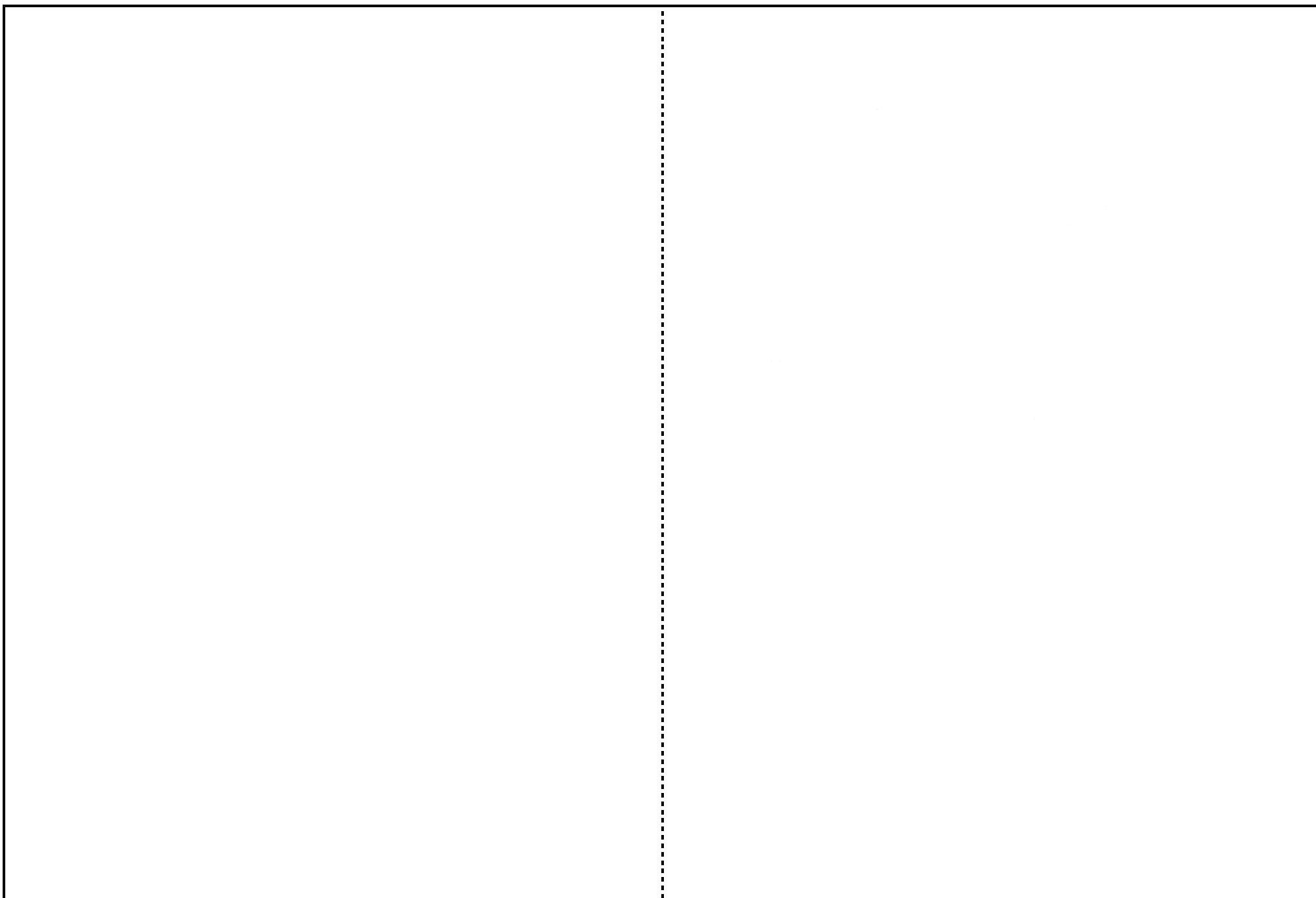

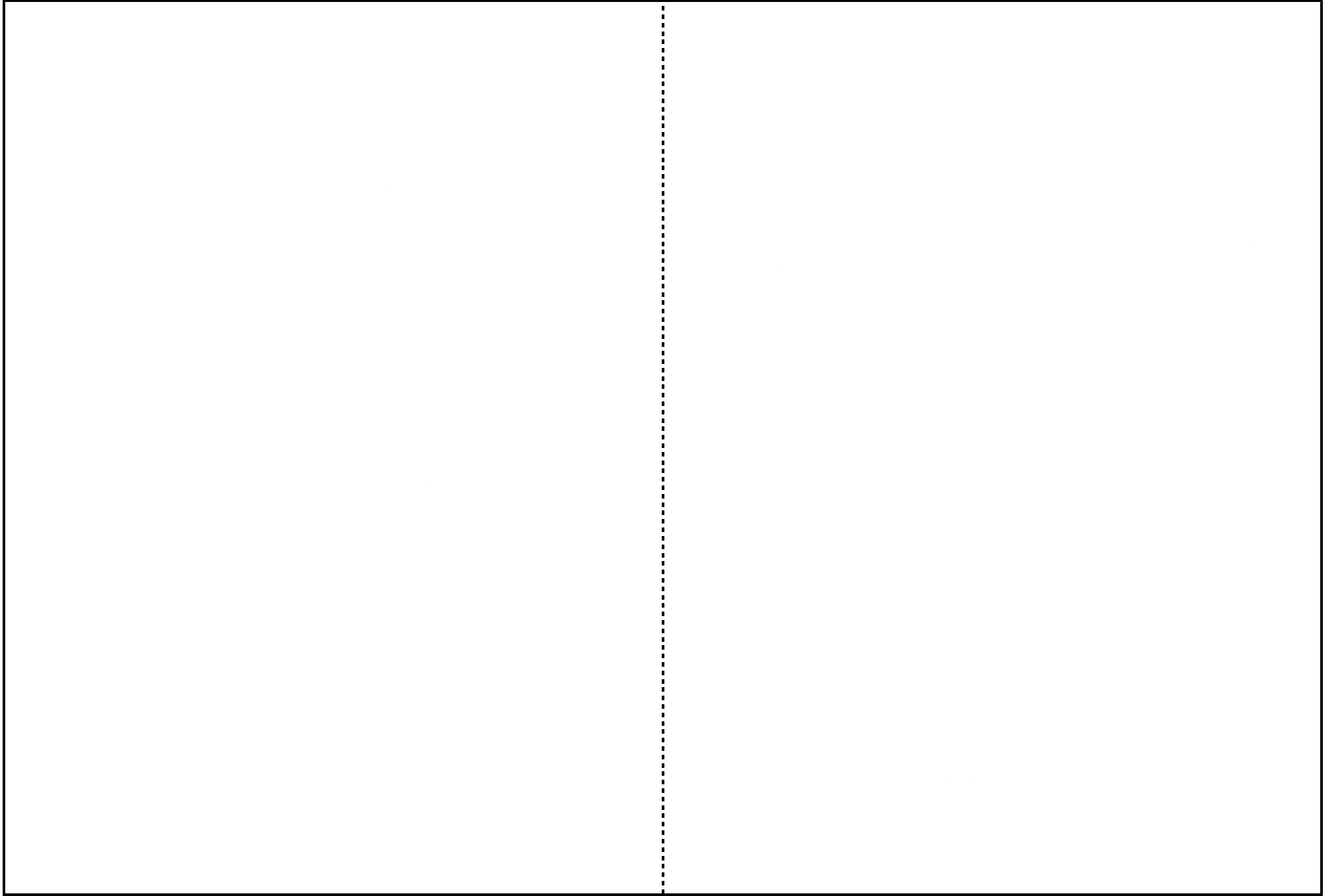

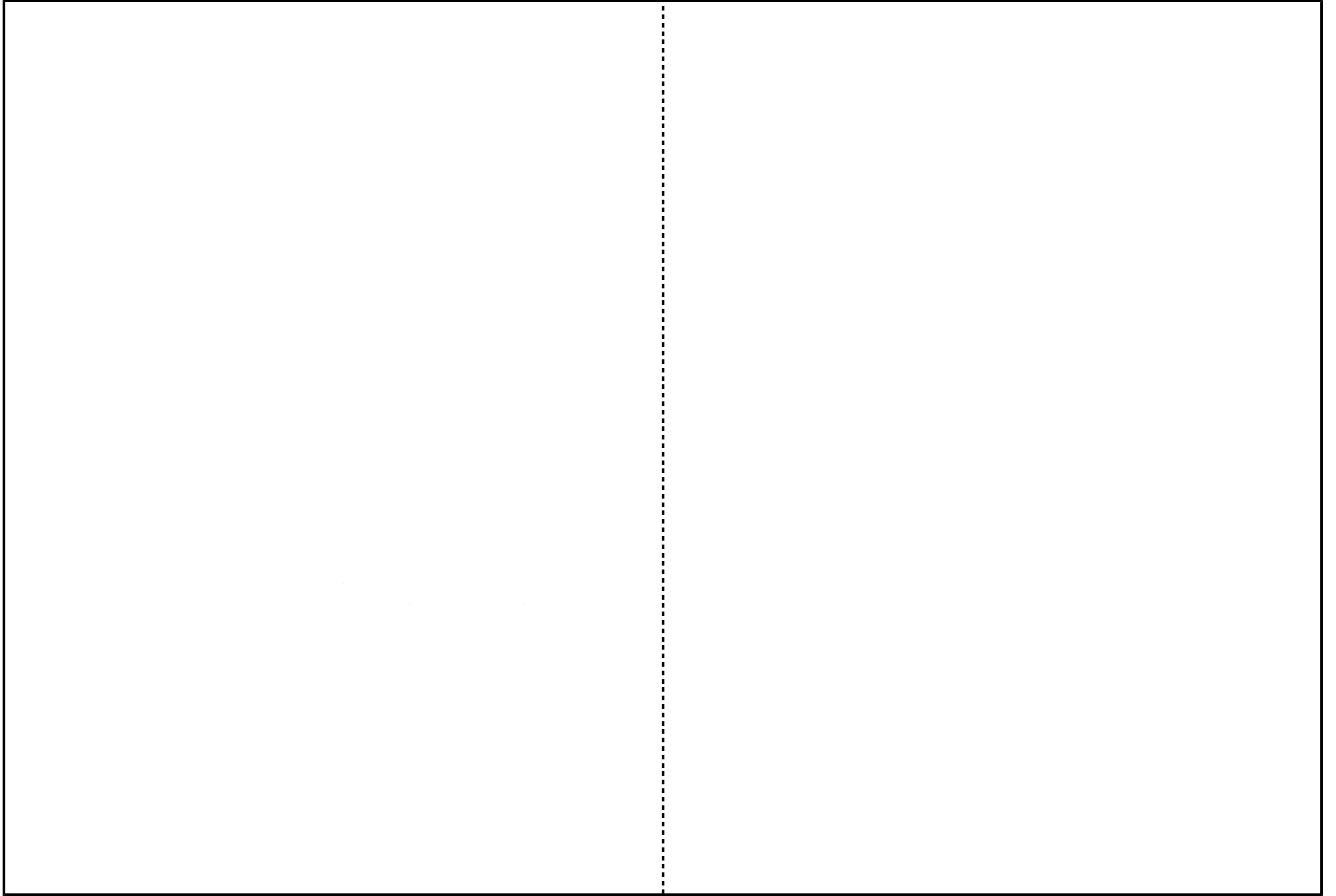

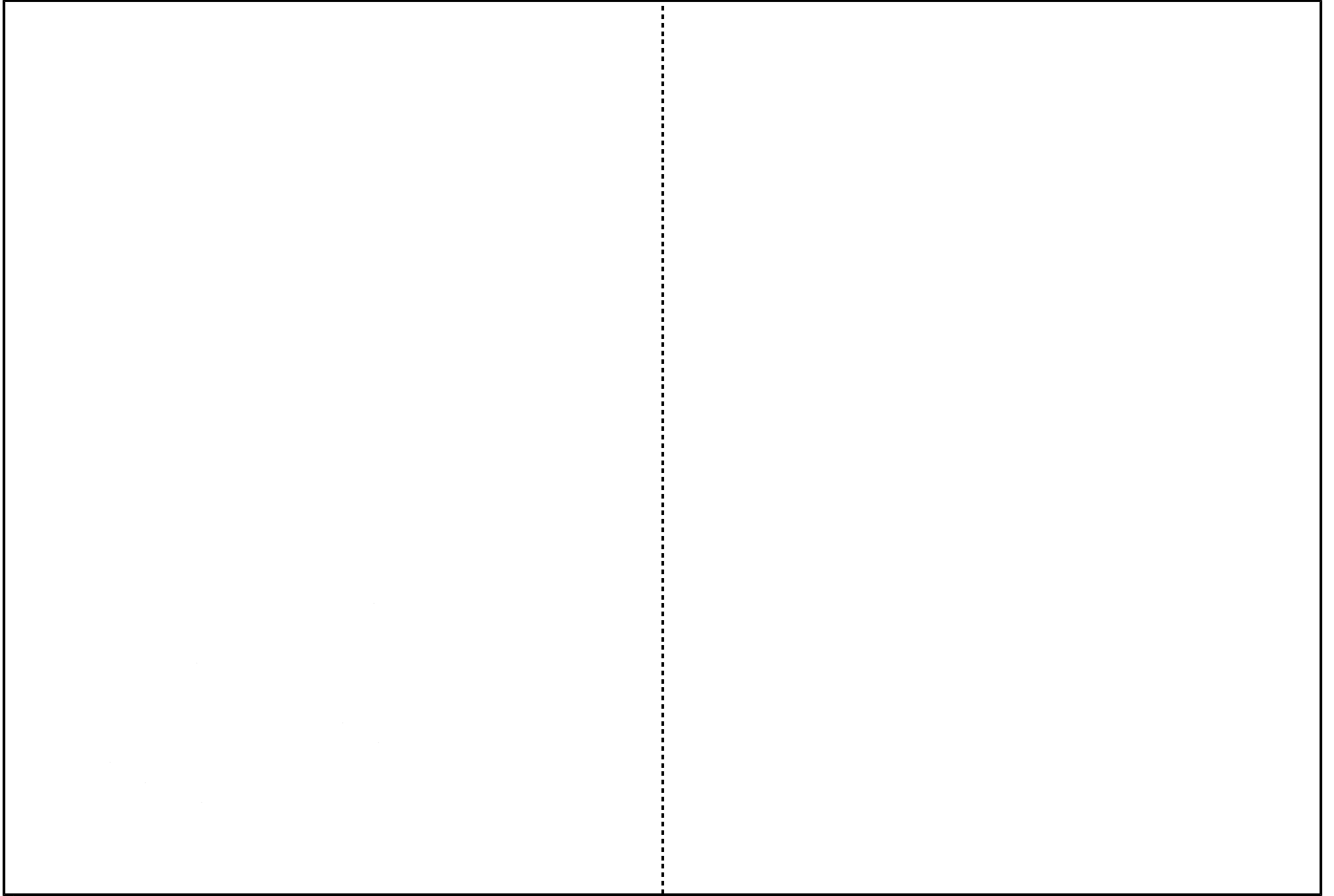

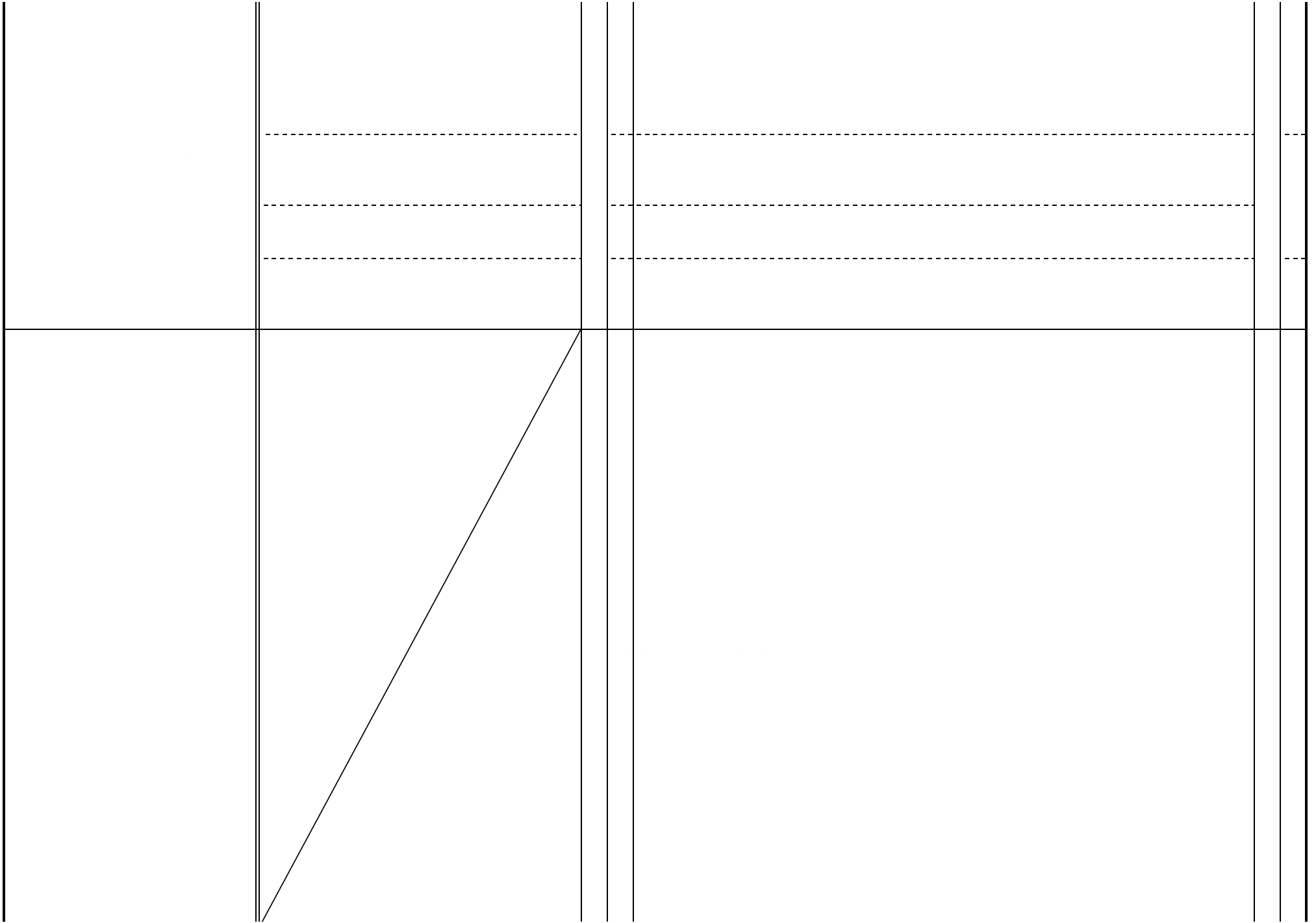

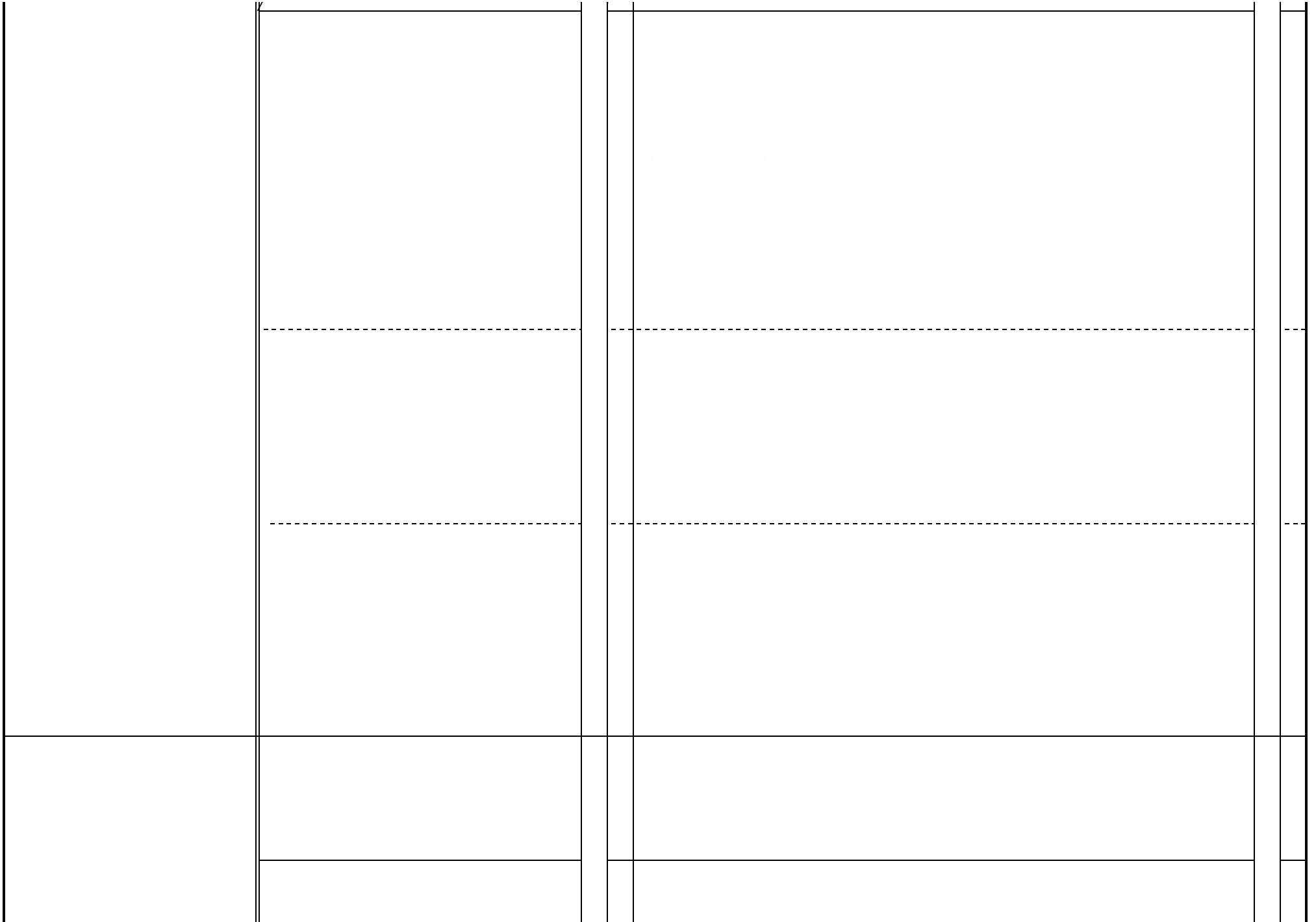

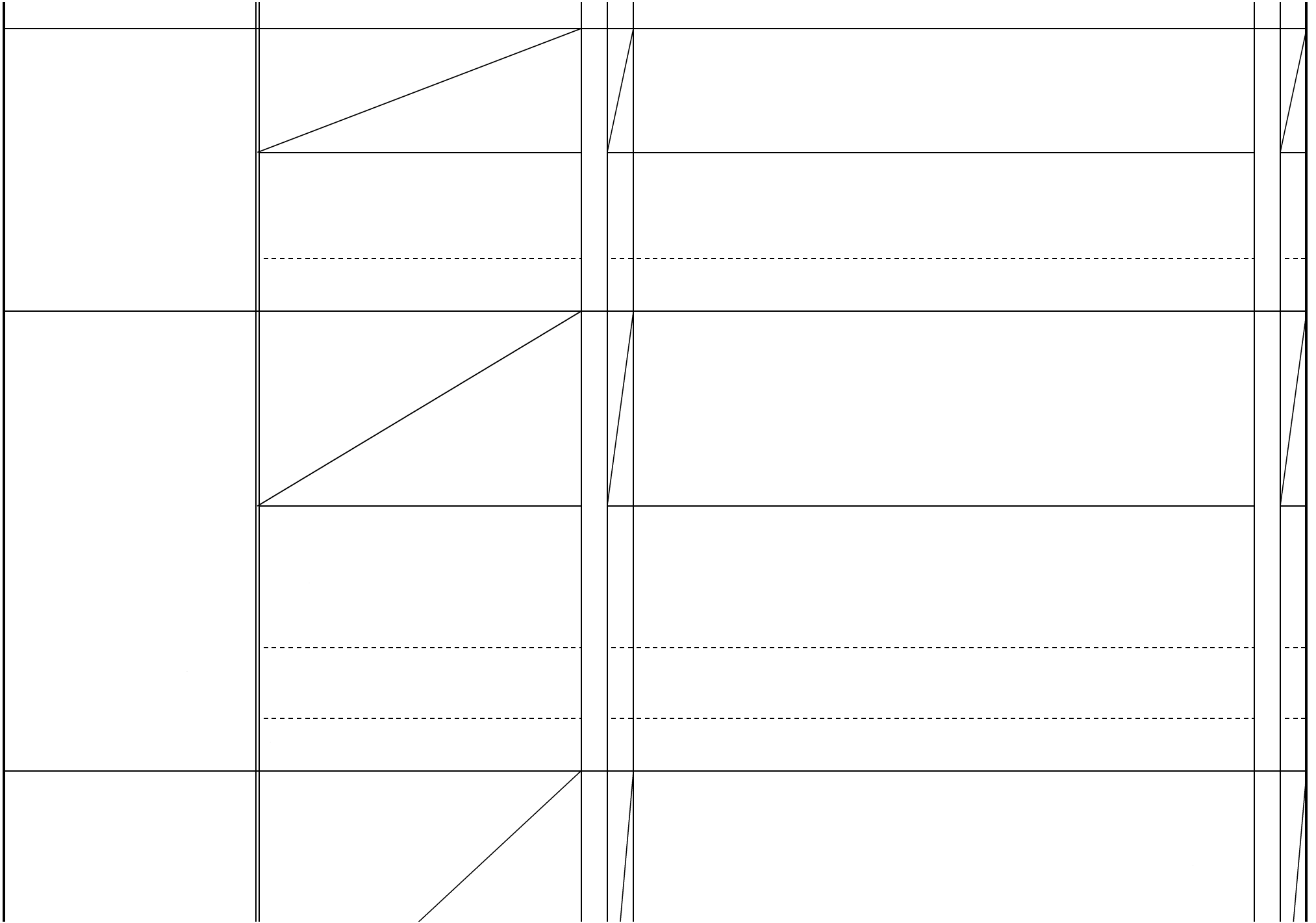

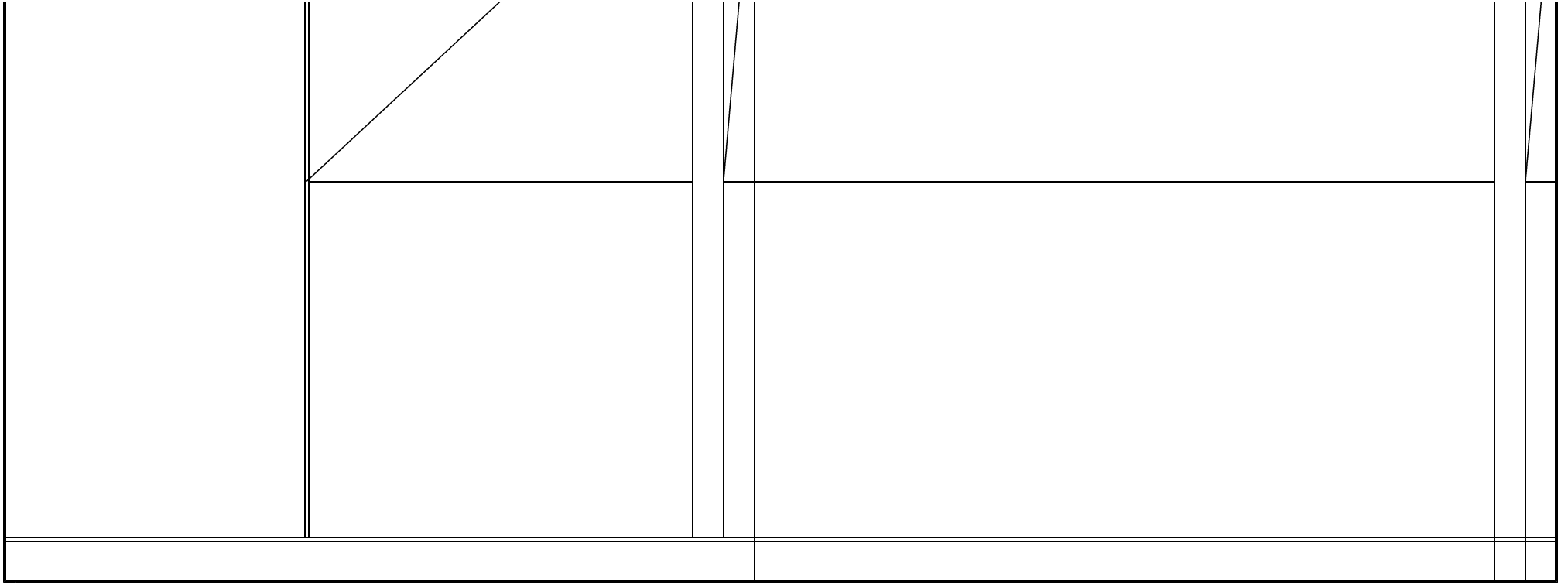

--

--

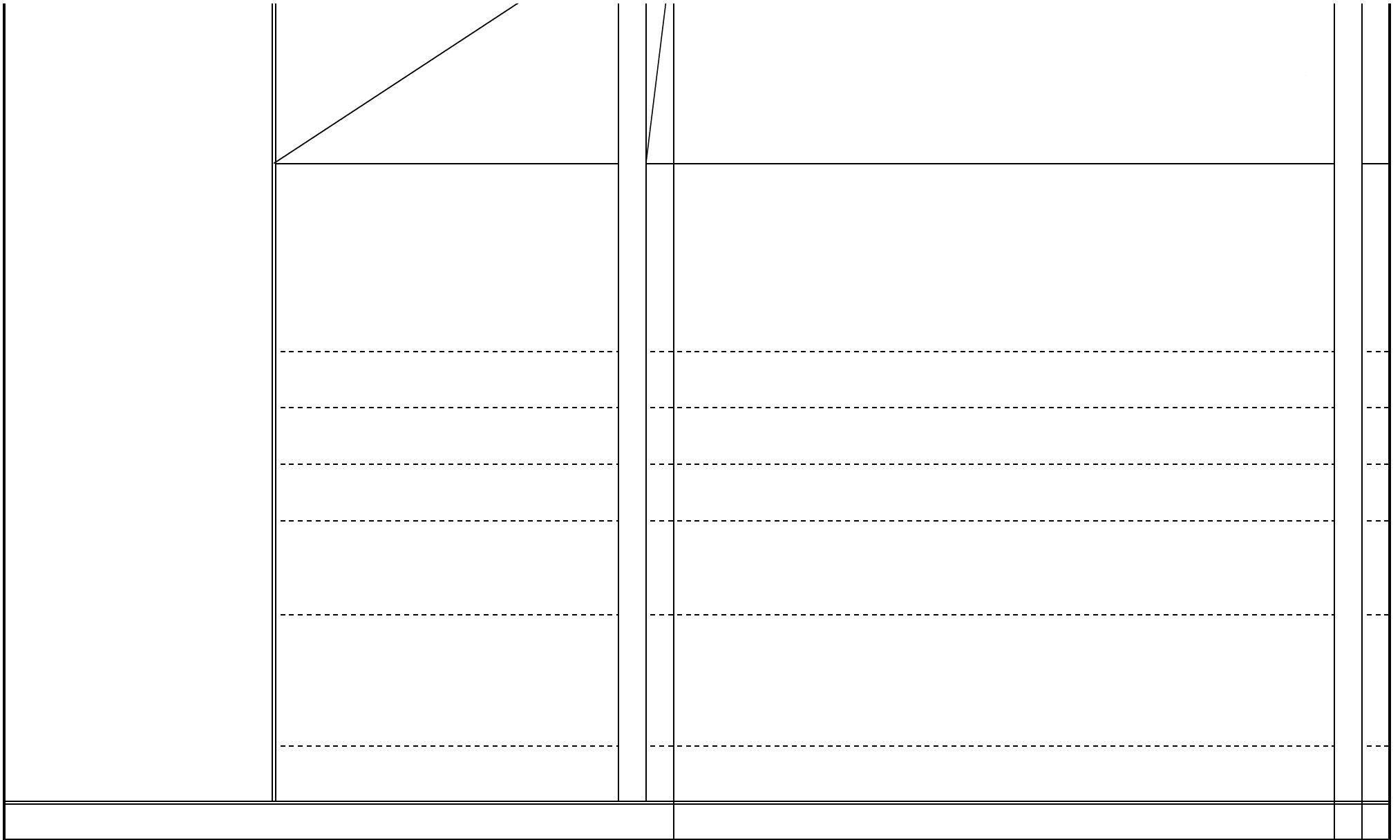

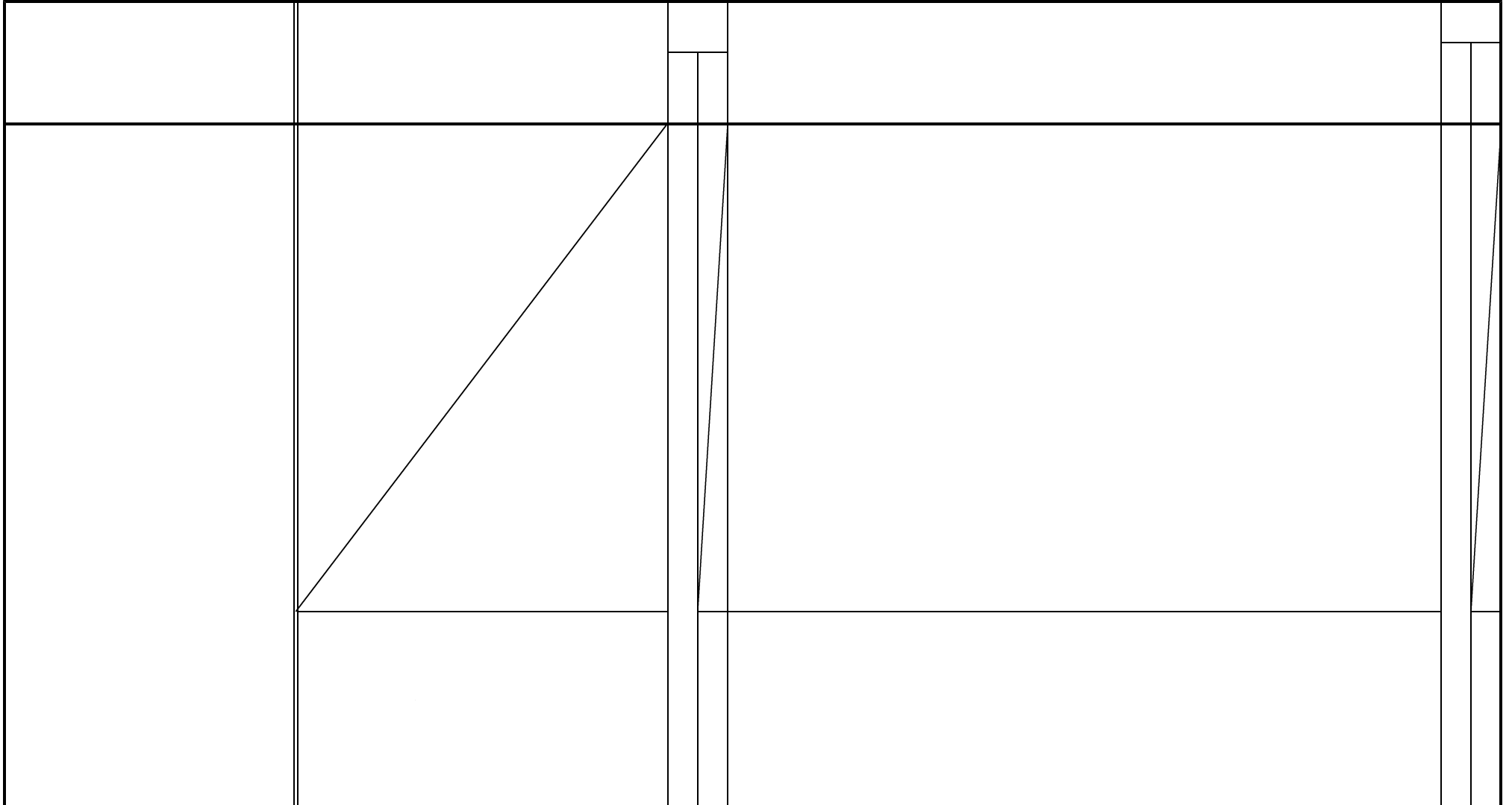

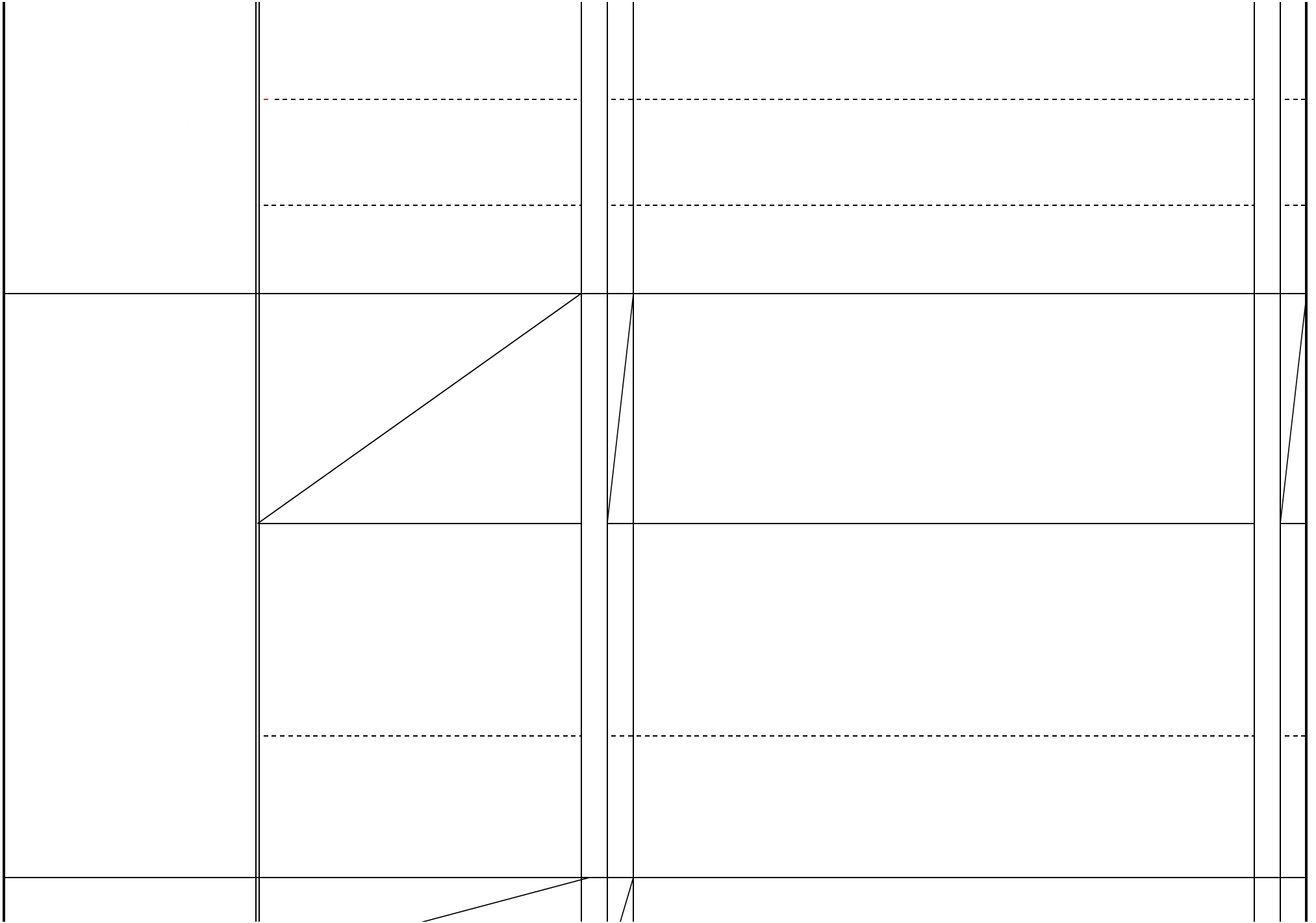

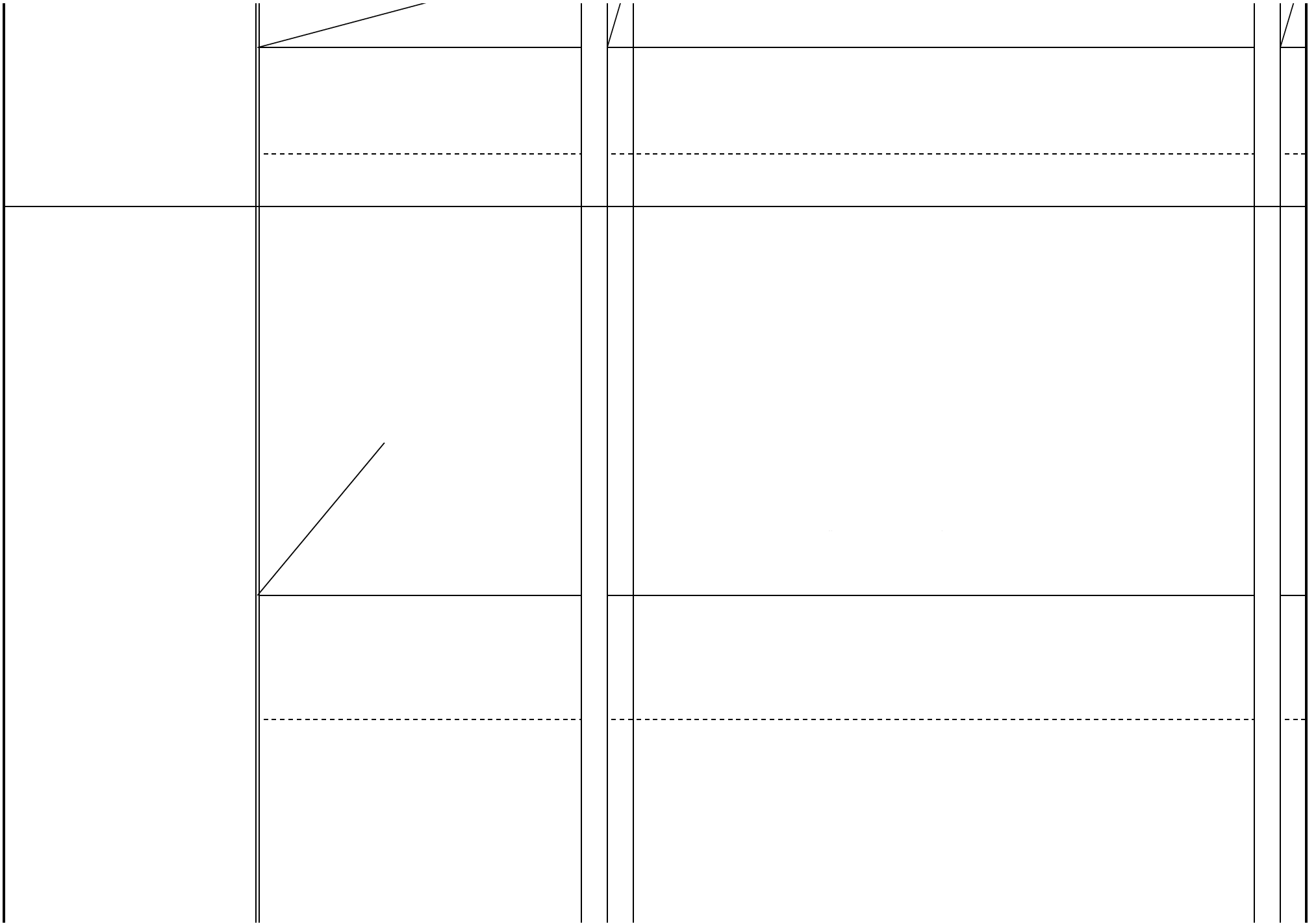

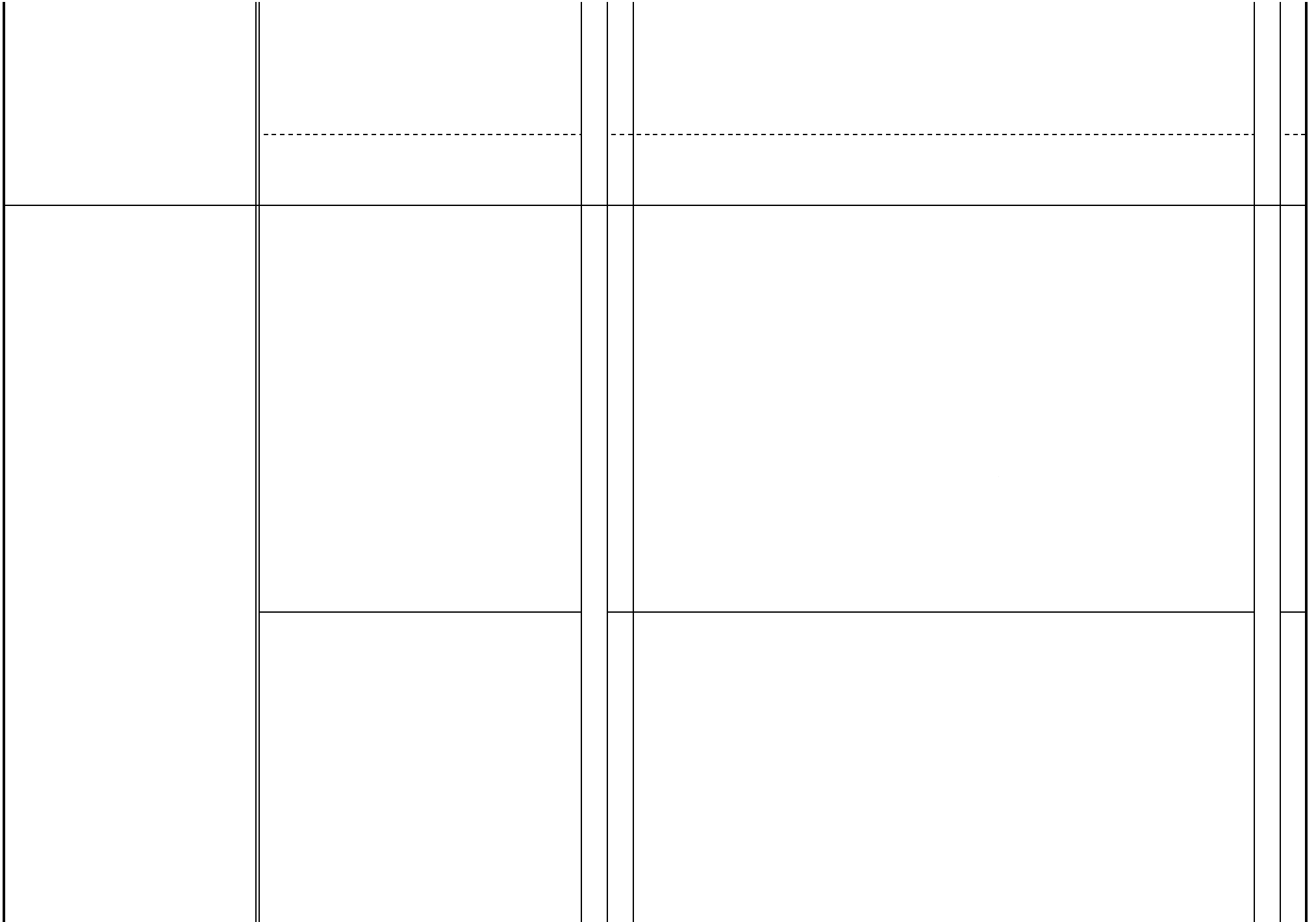

[Empty rectangular box]

[Empty rectangular box]

	/			

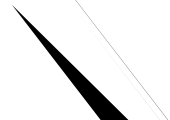

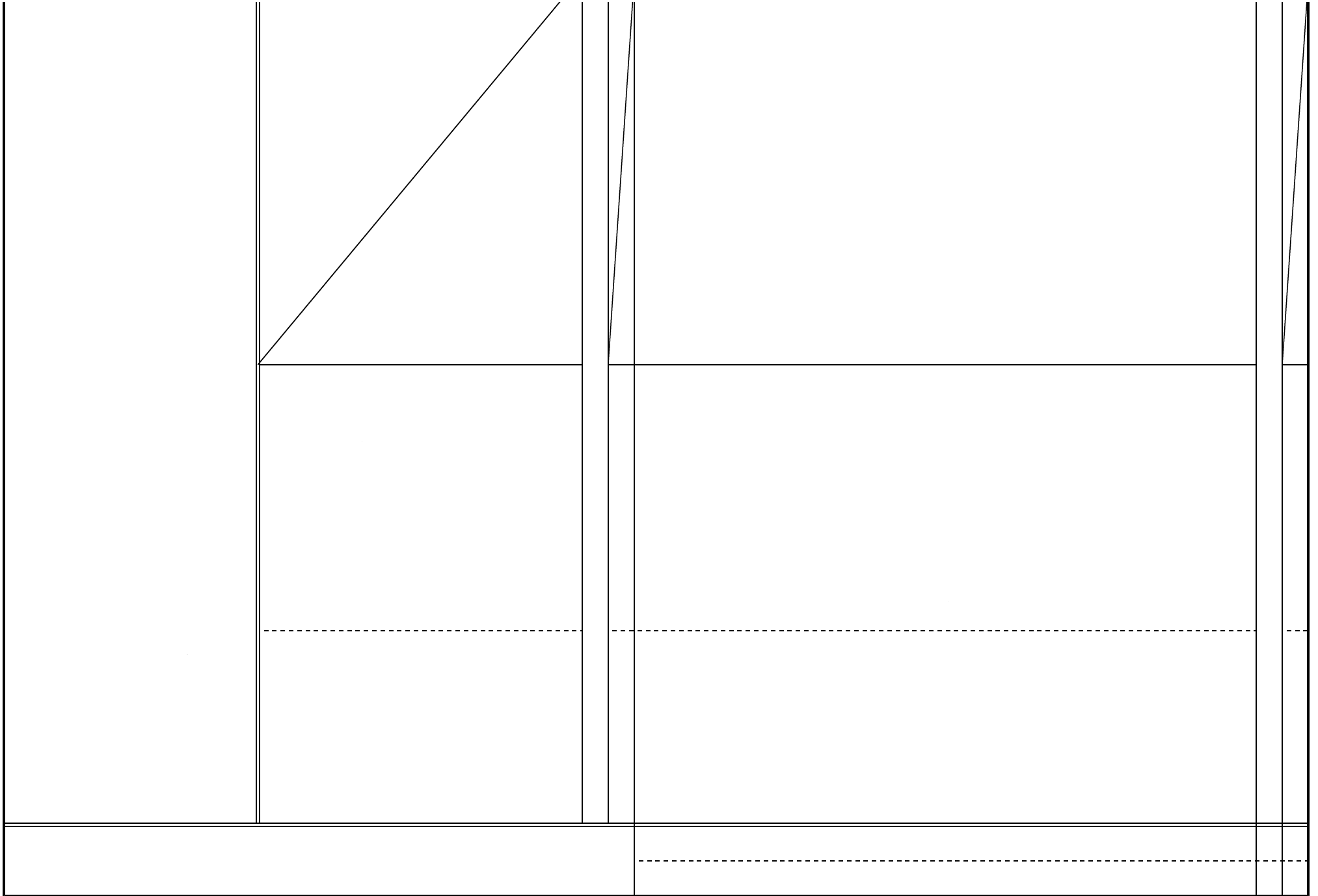

[Redacted]

[Redacted]



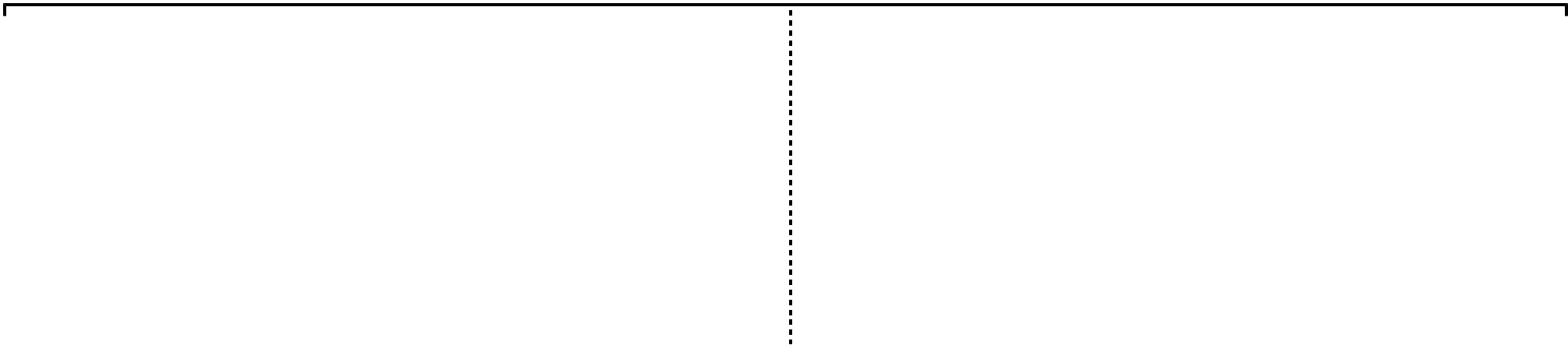

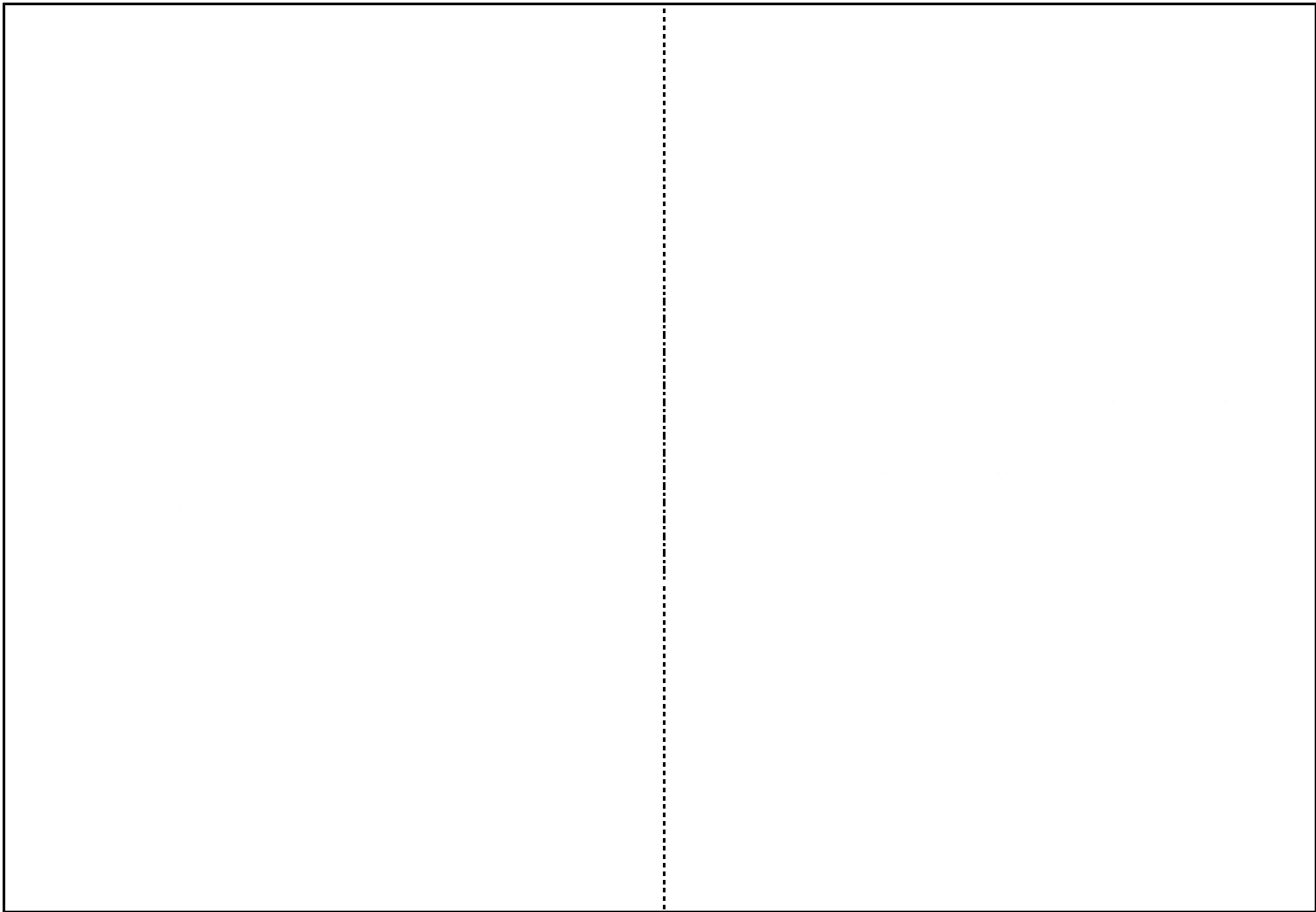

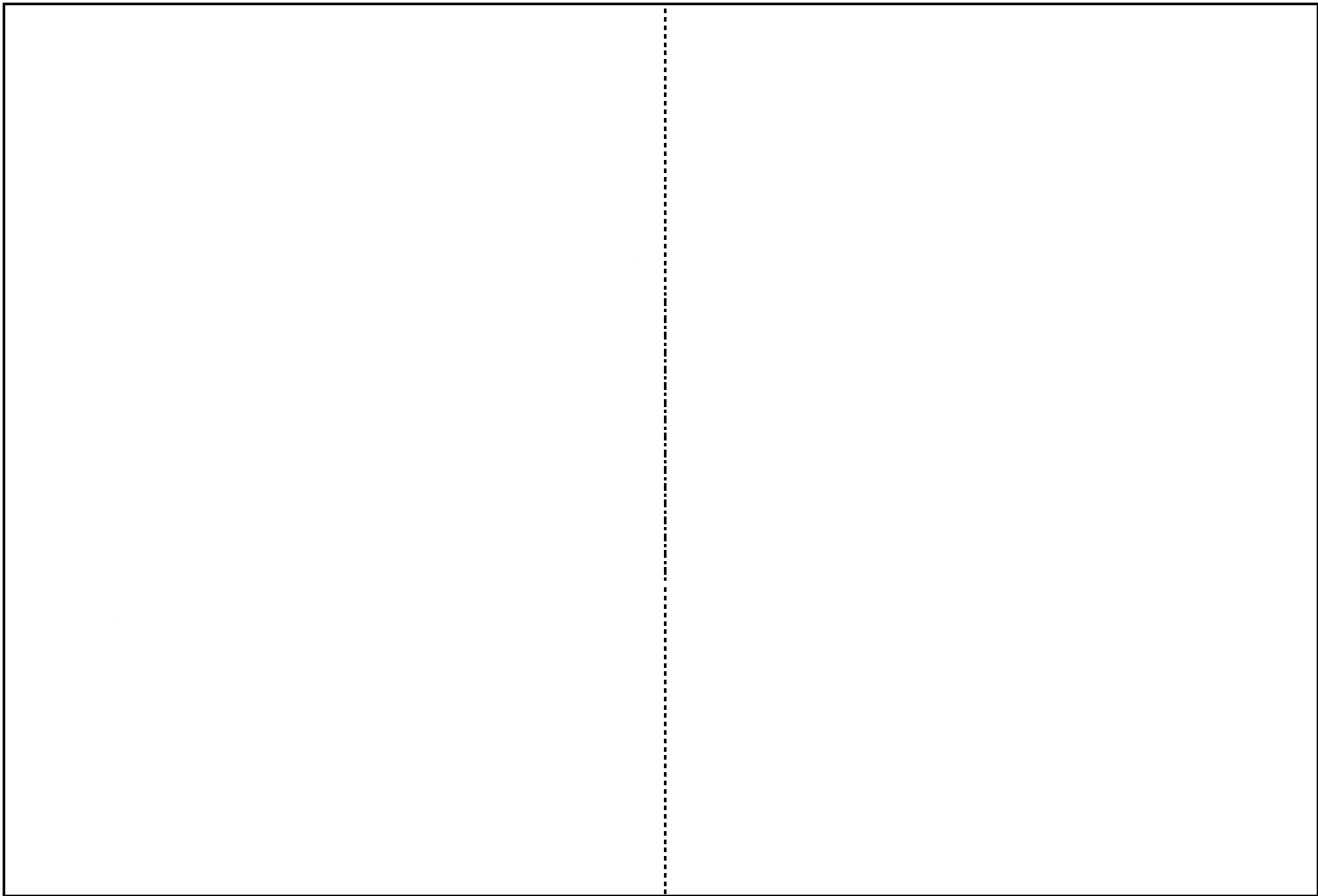

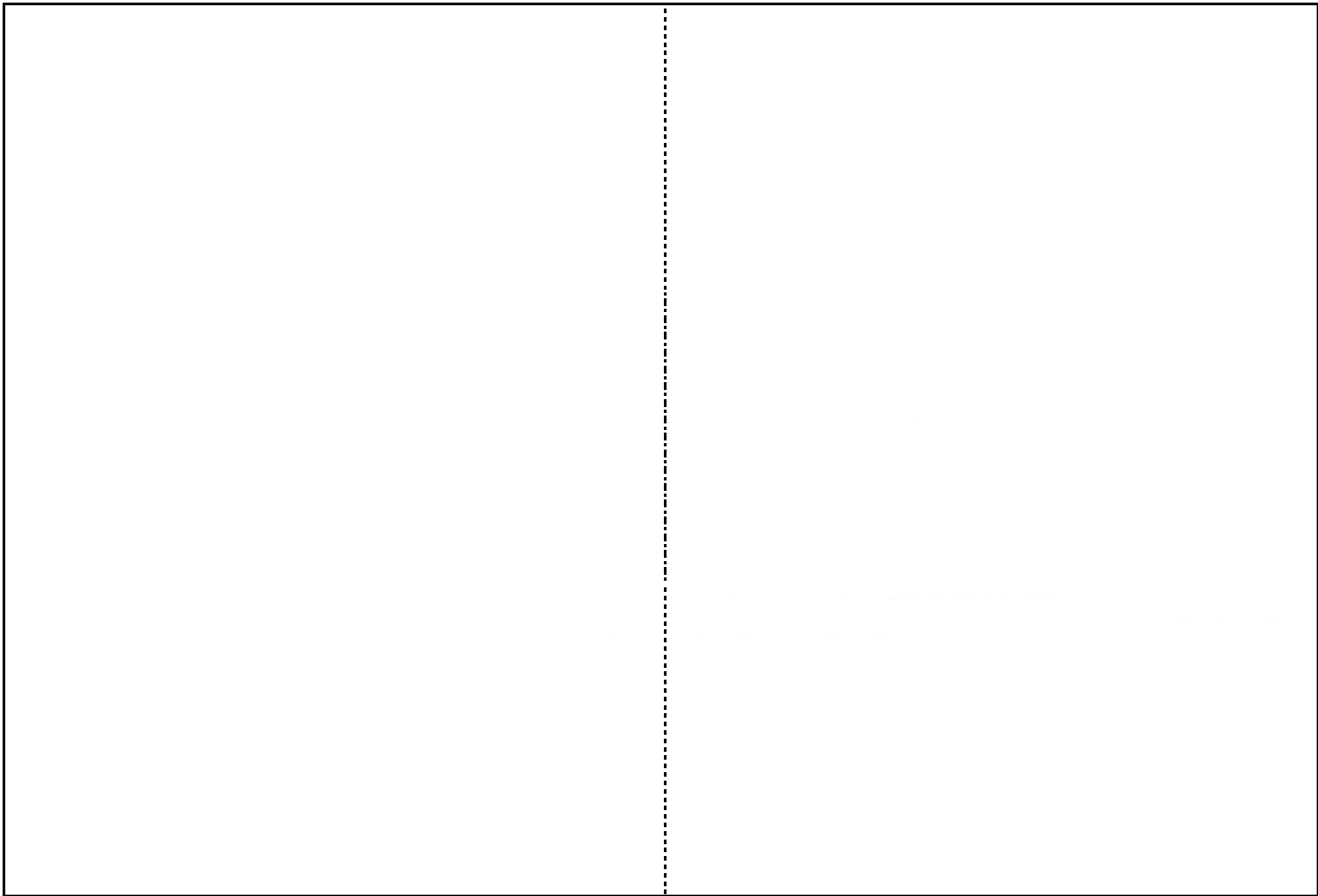

(2)

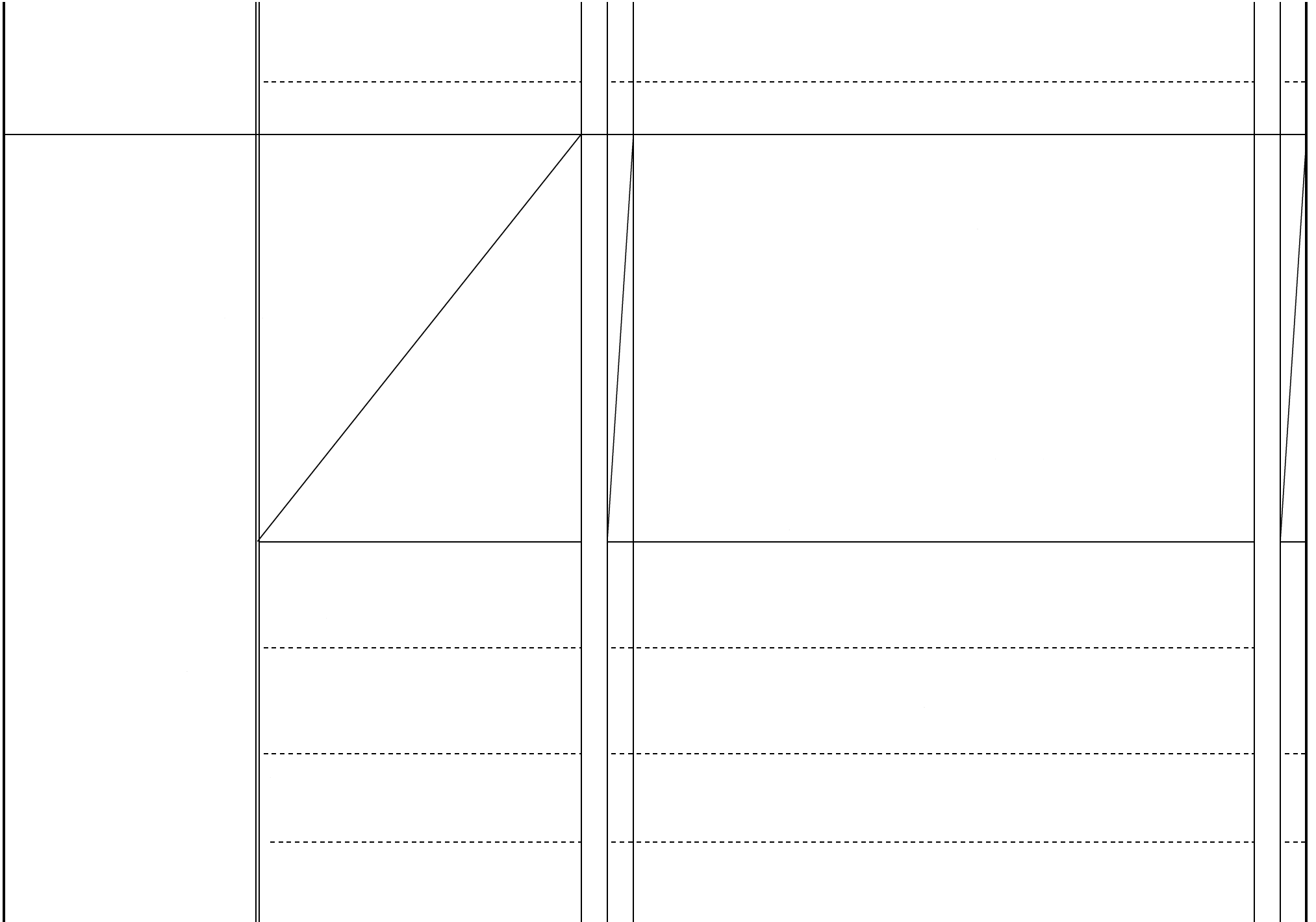

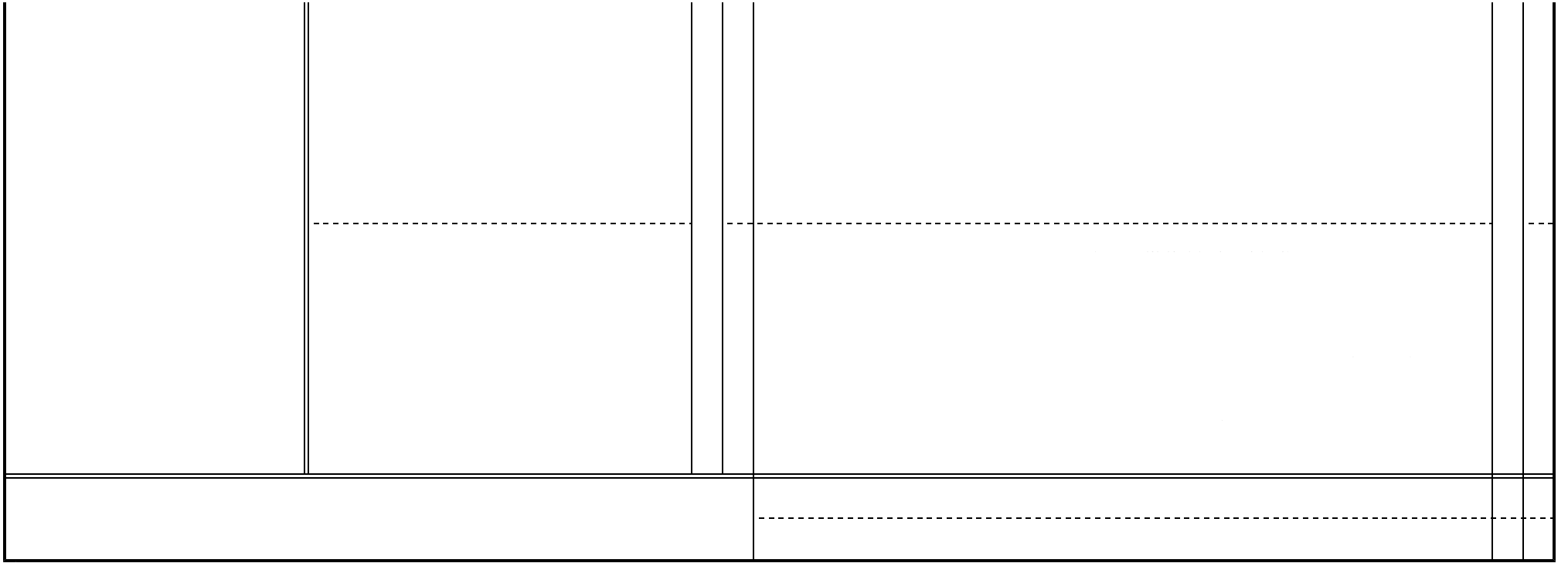

(2)

--

Blank header box

--	--

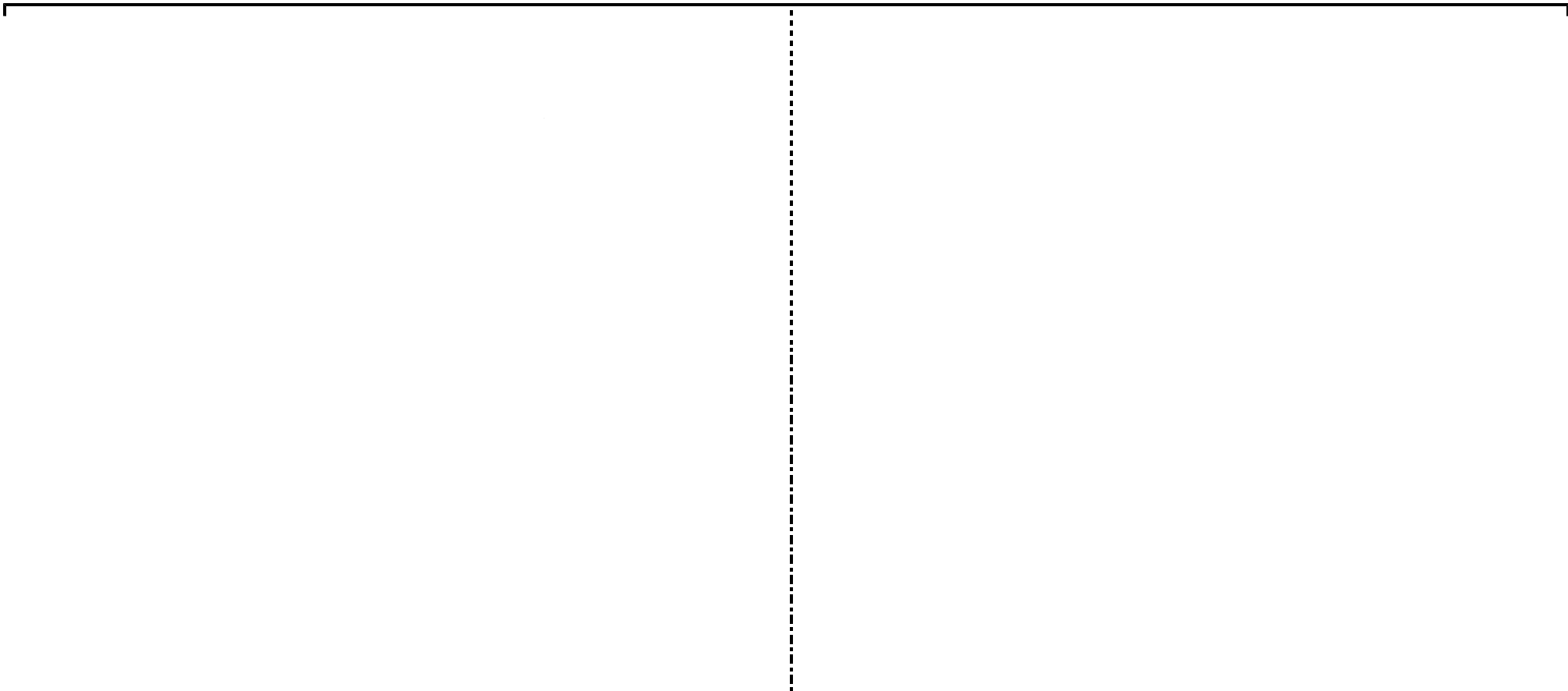

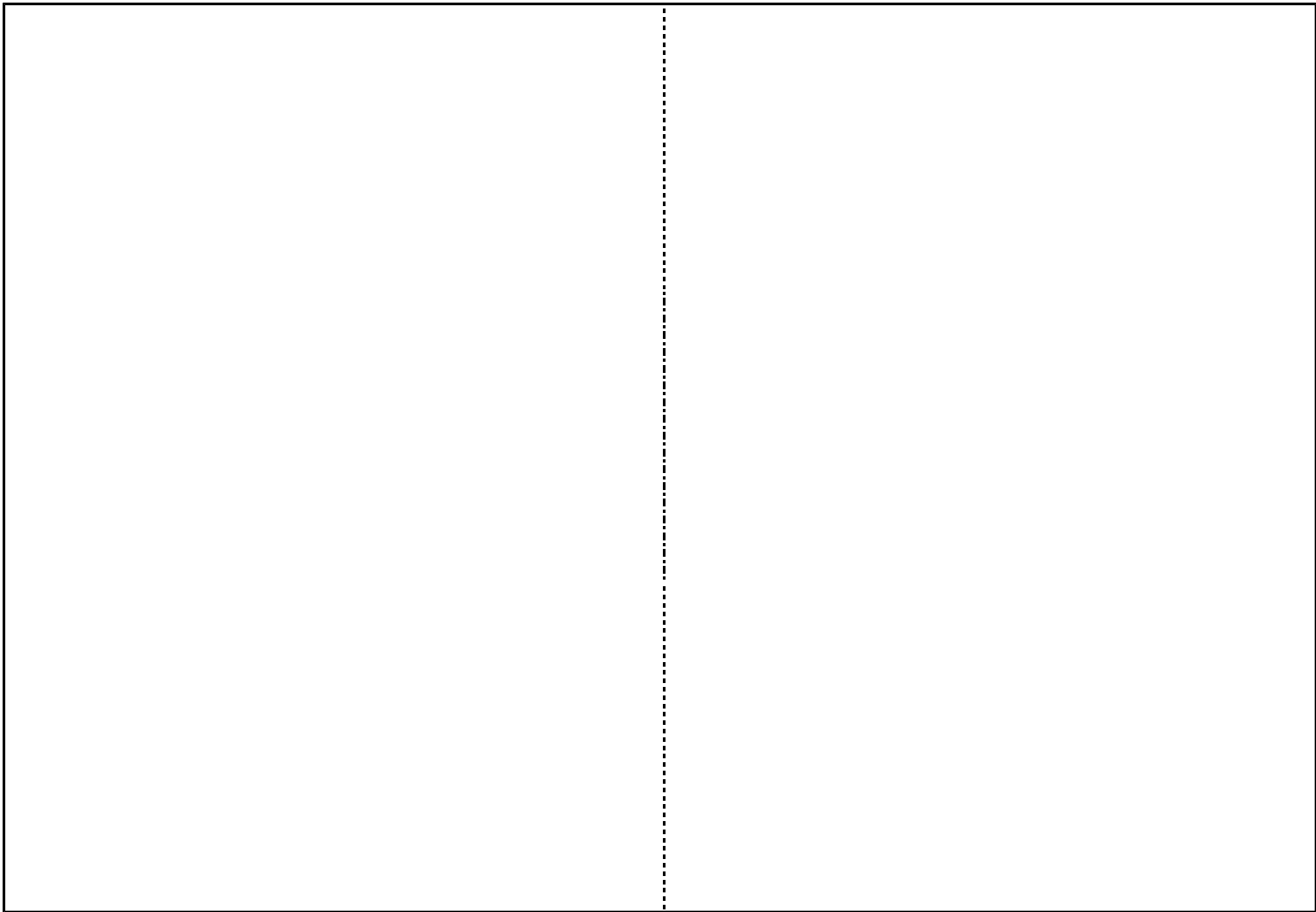

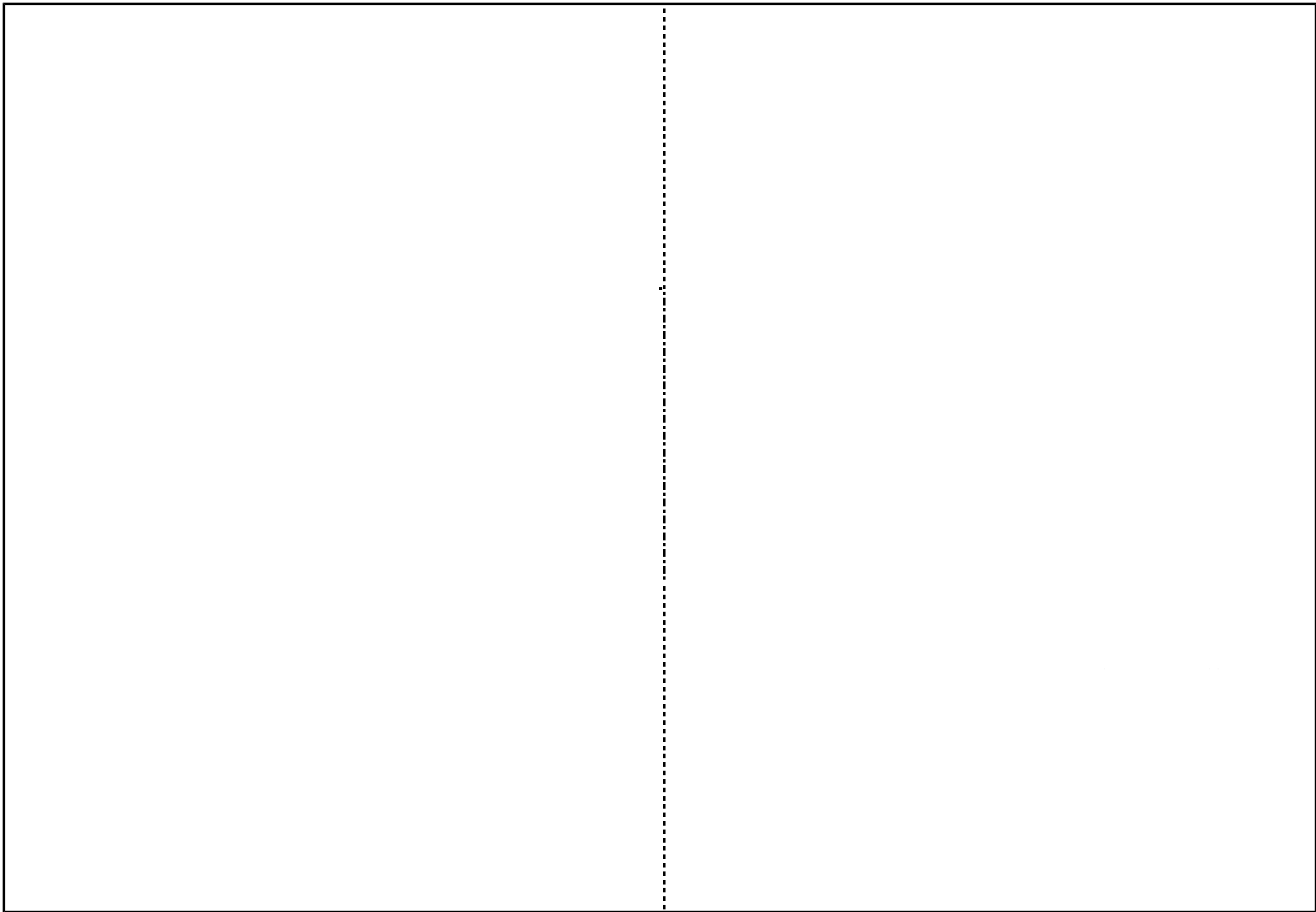

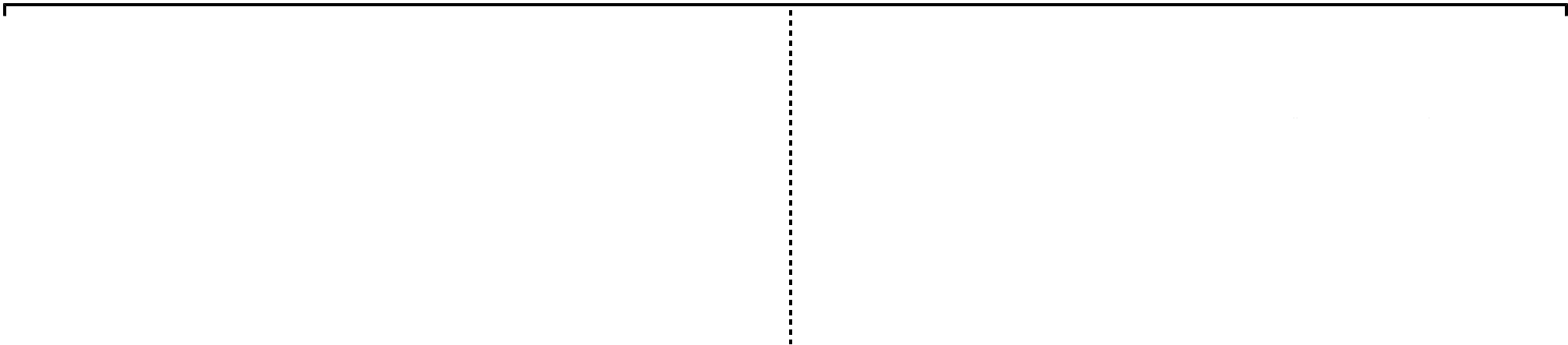

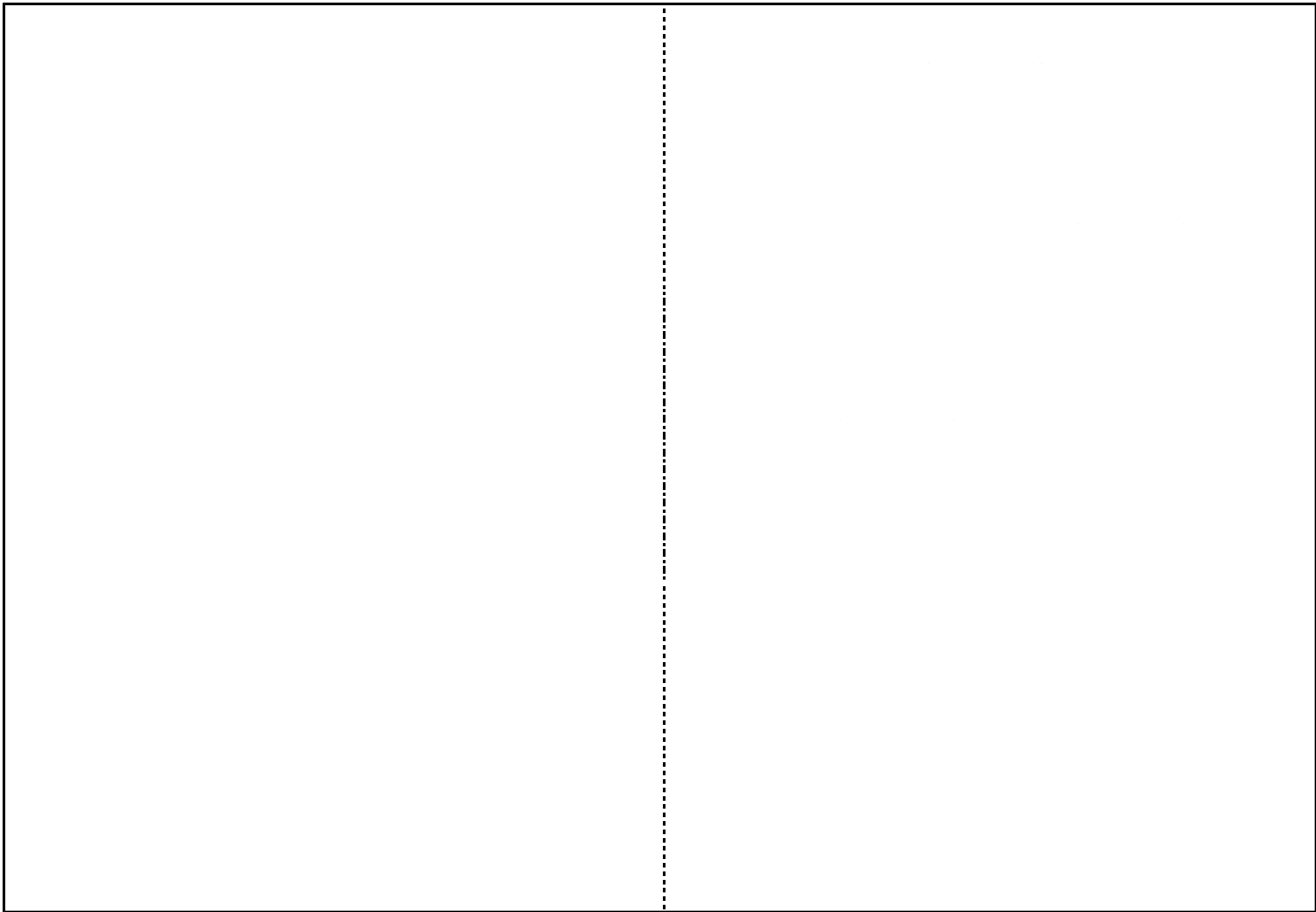

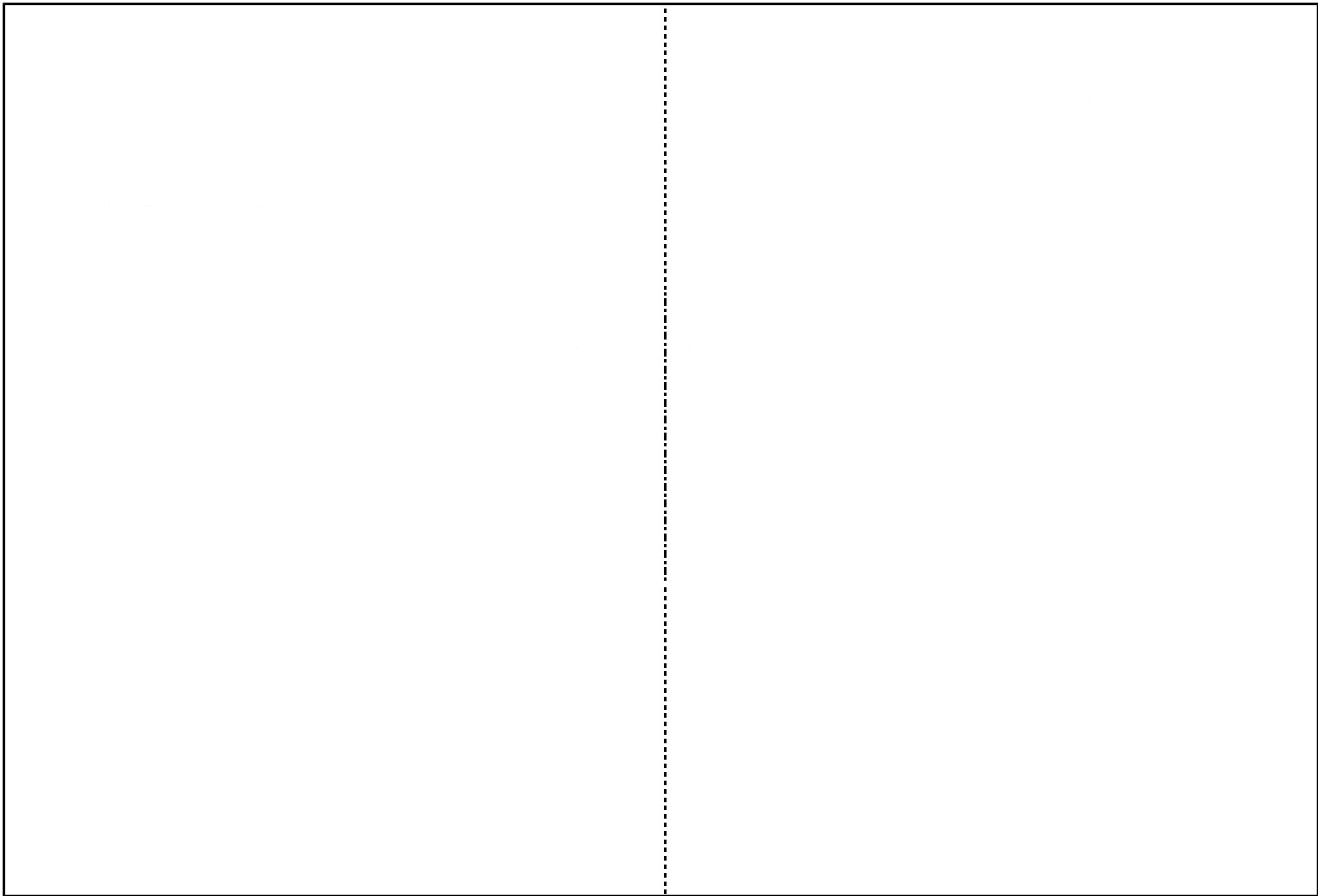

(3)

--	--

Blank header box

--	--

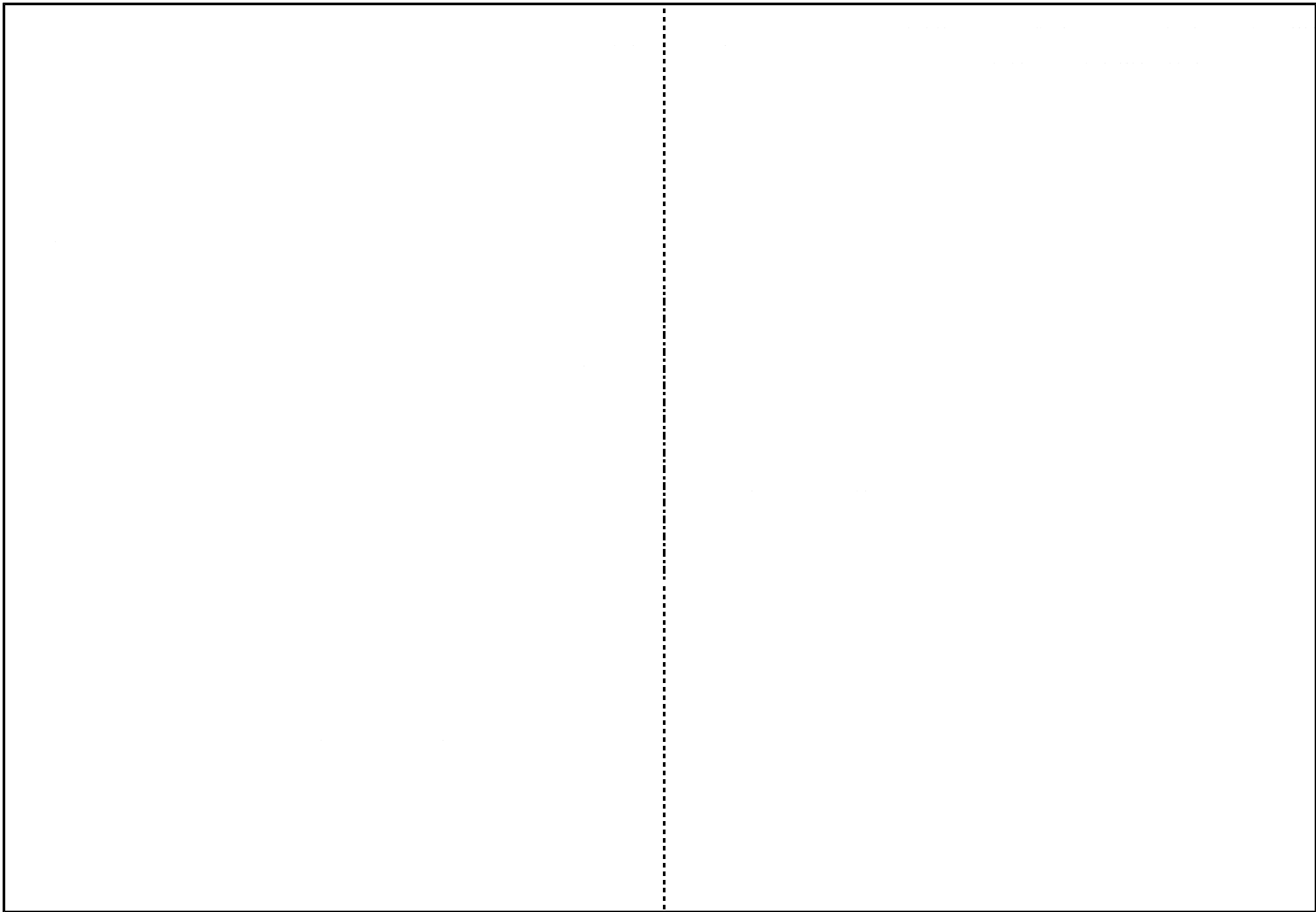

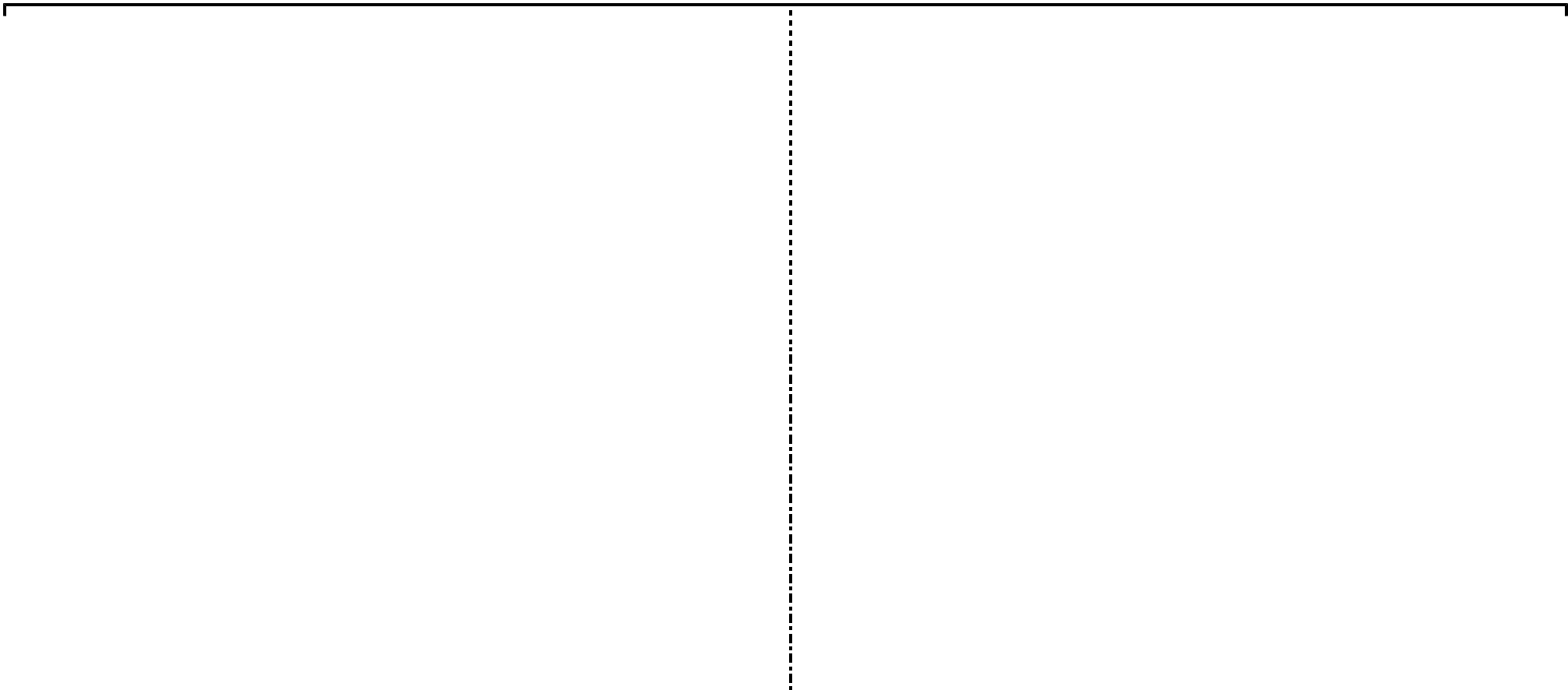

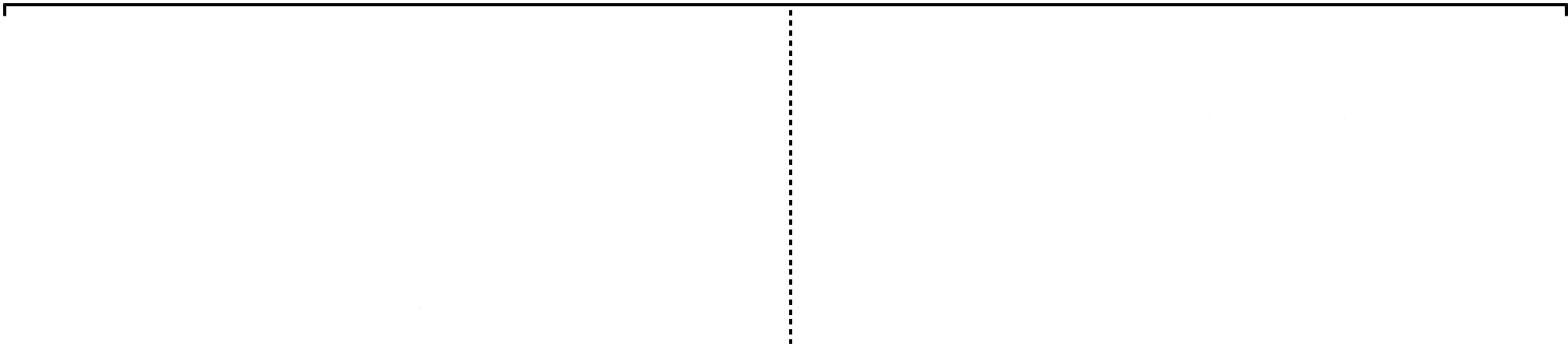

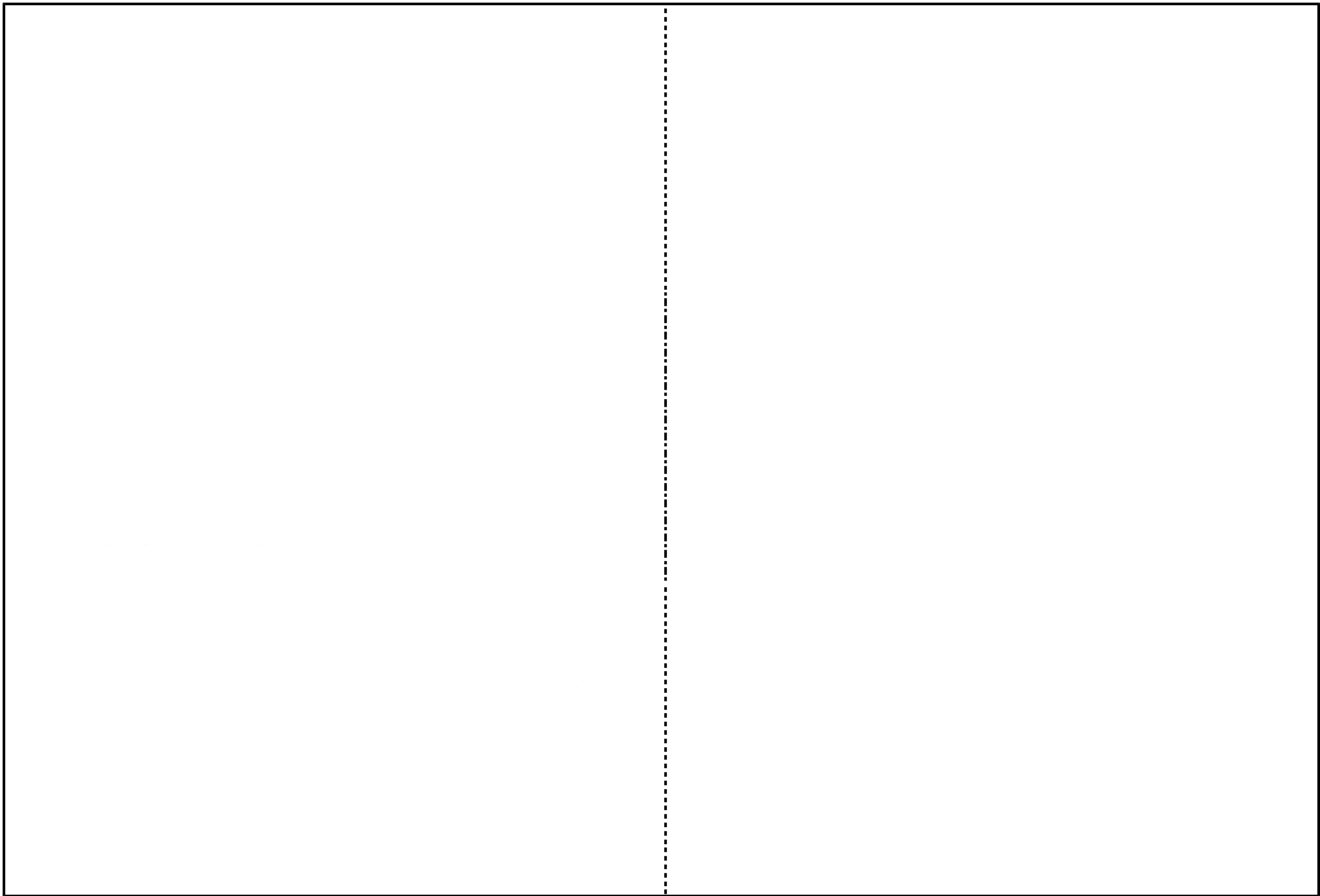

(4)

--

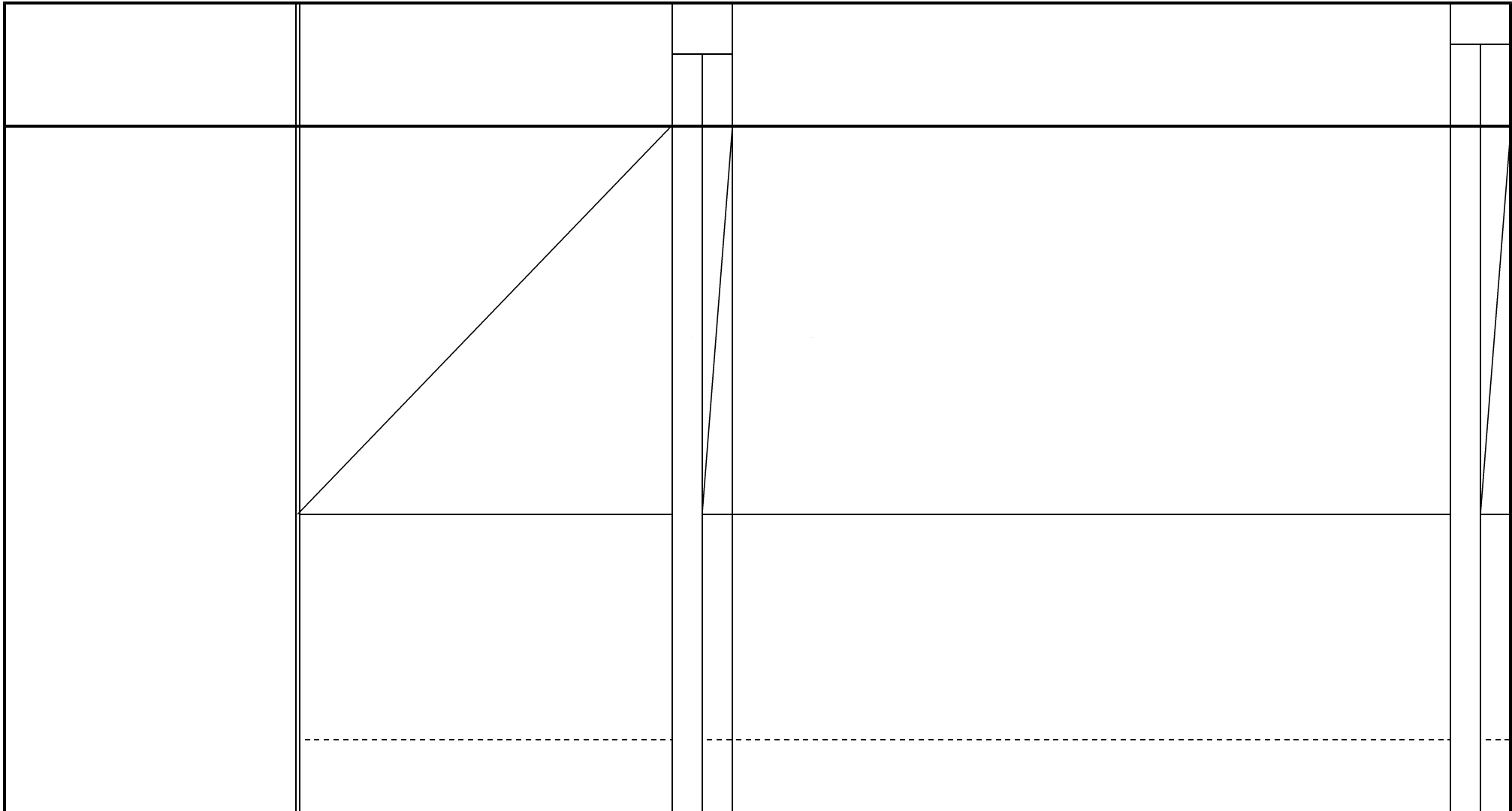

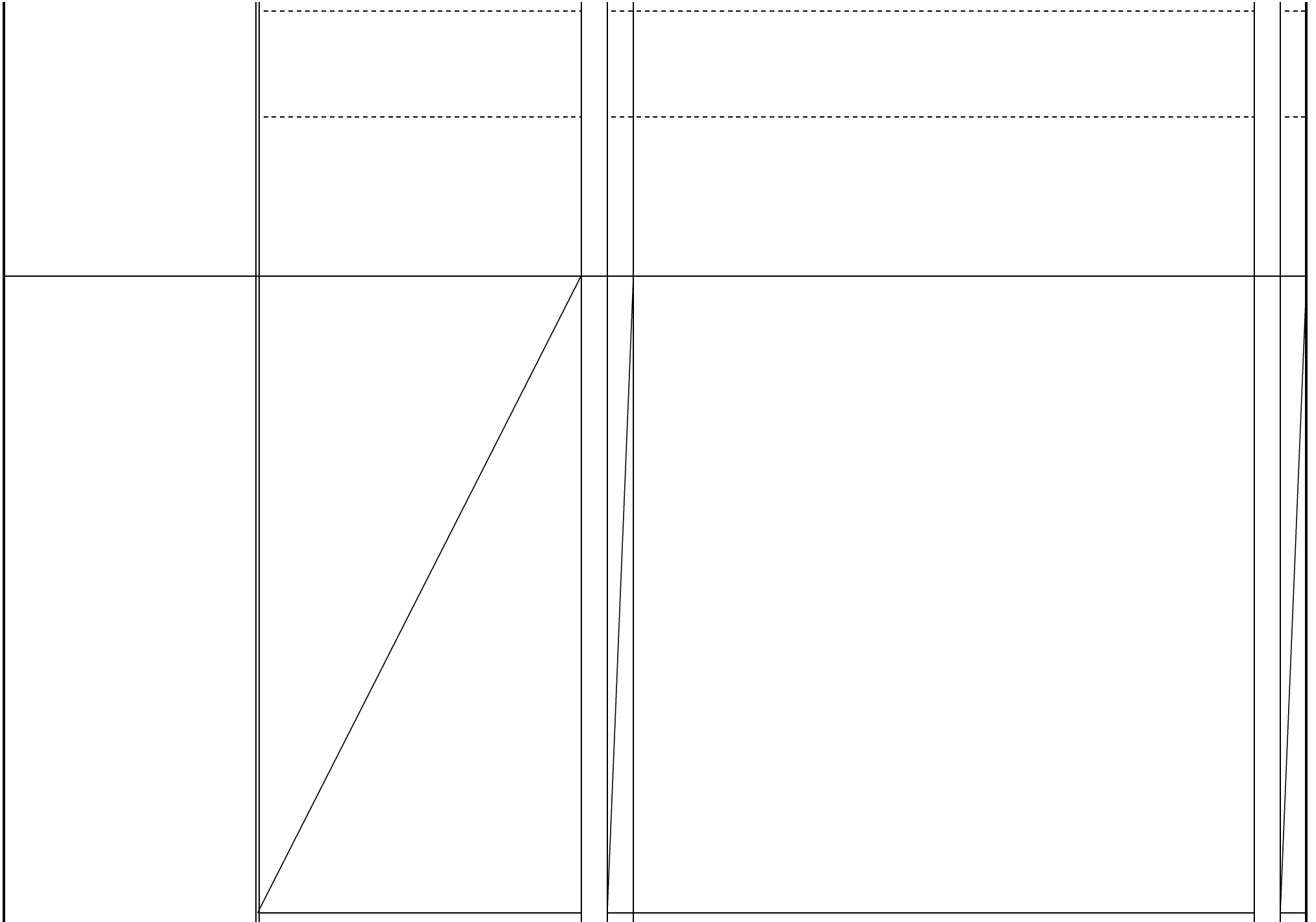

--	--

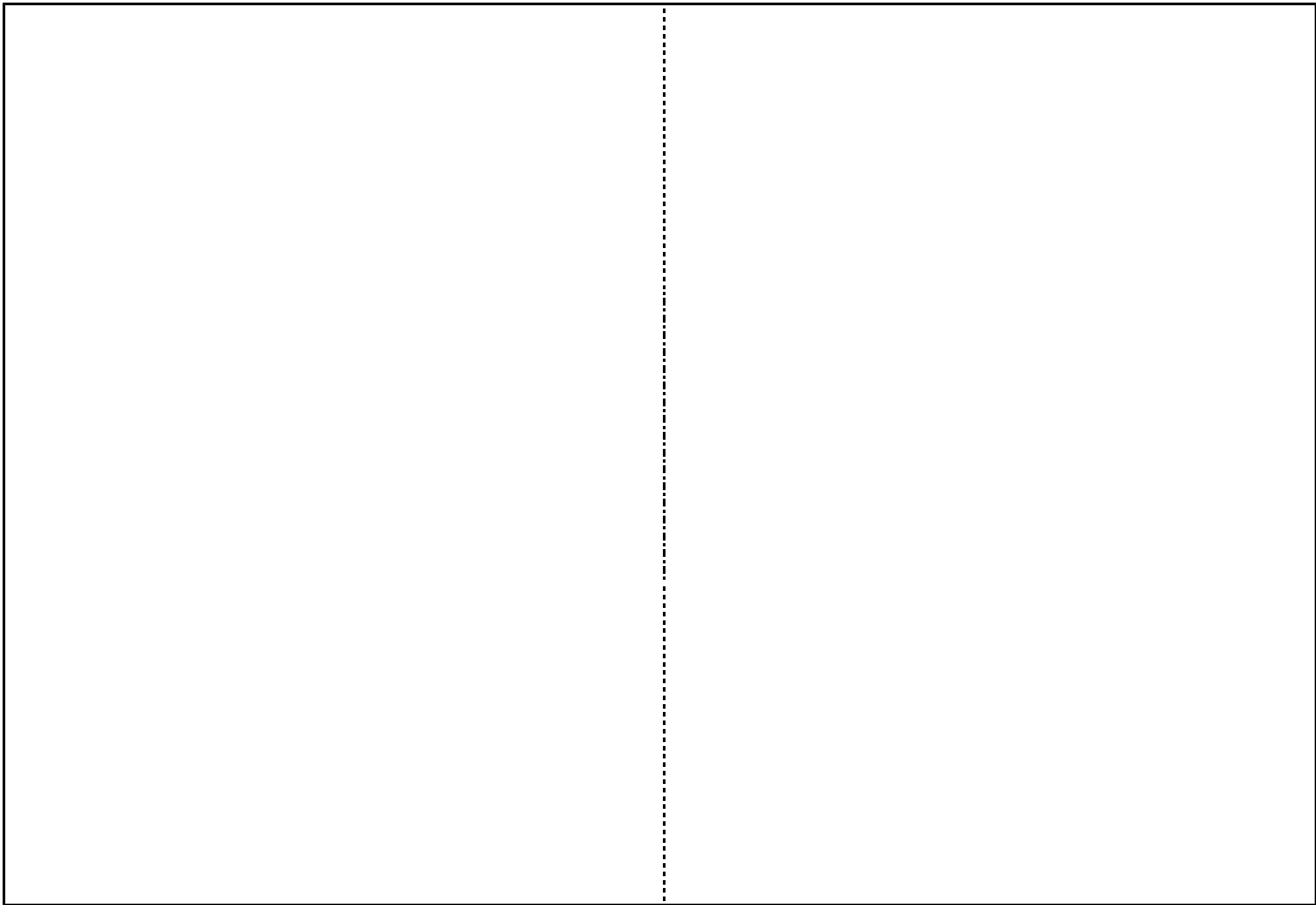

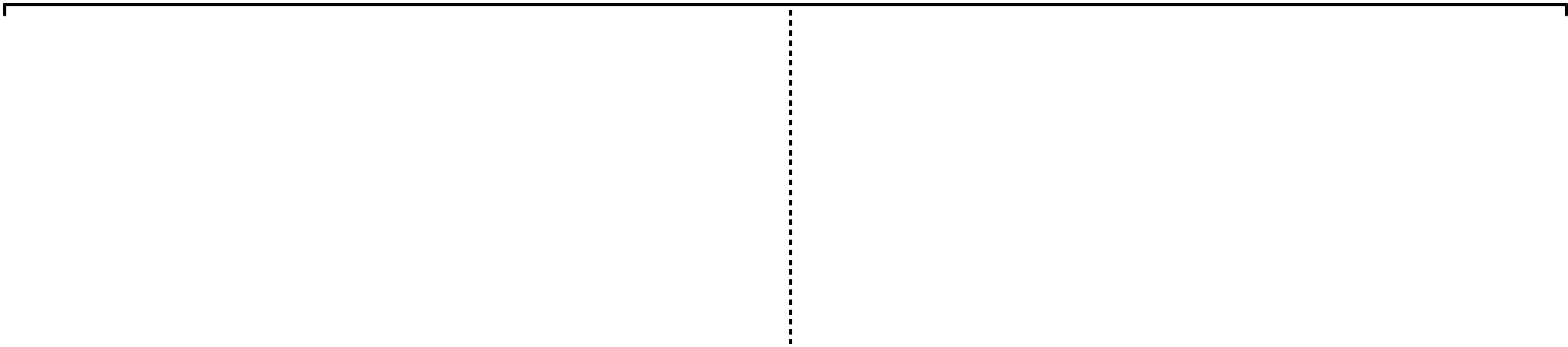

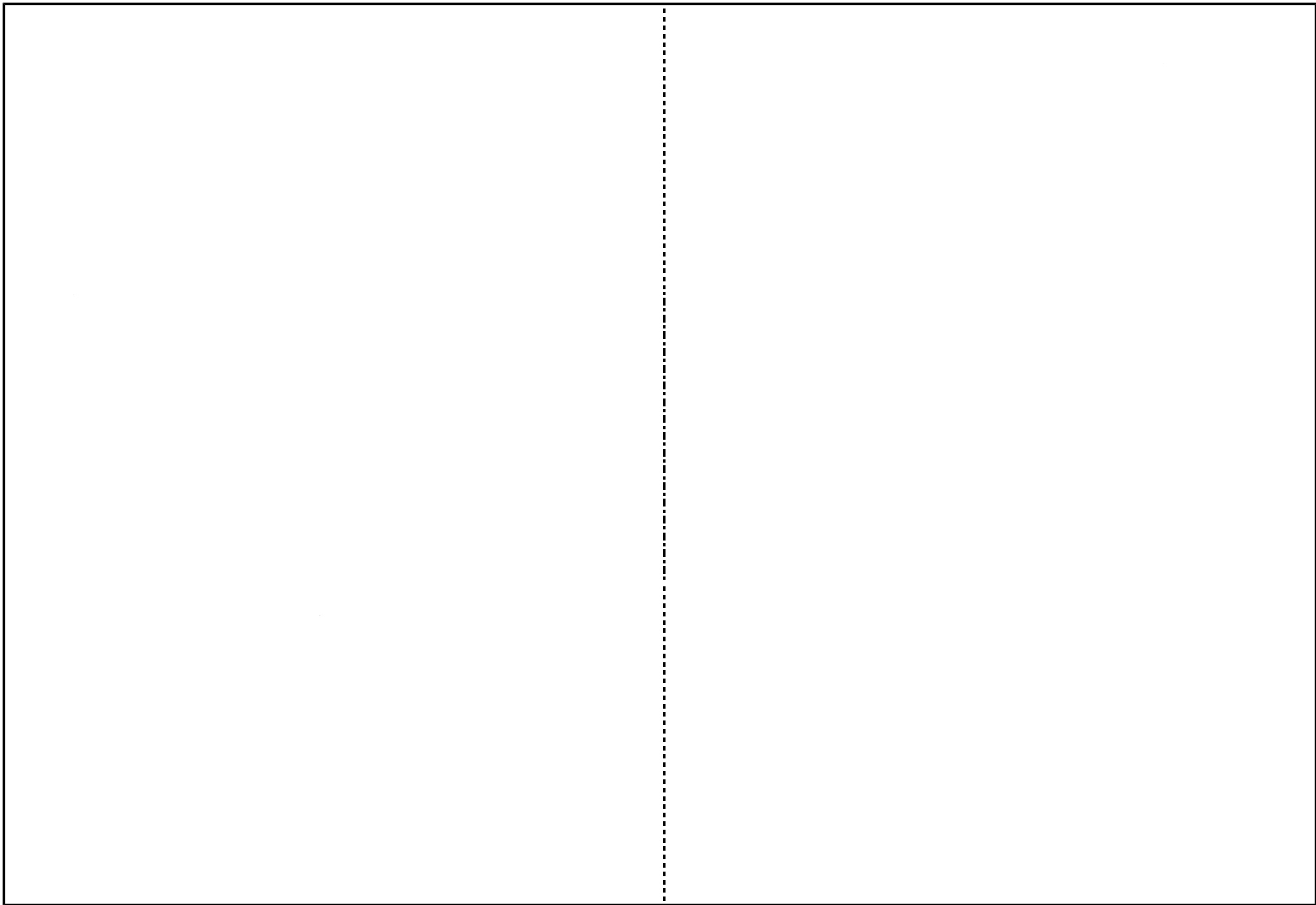

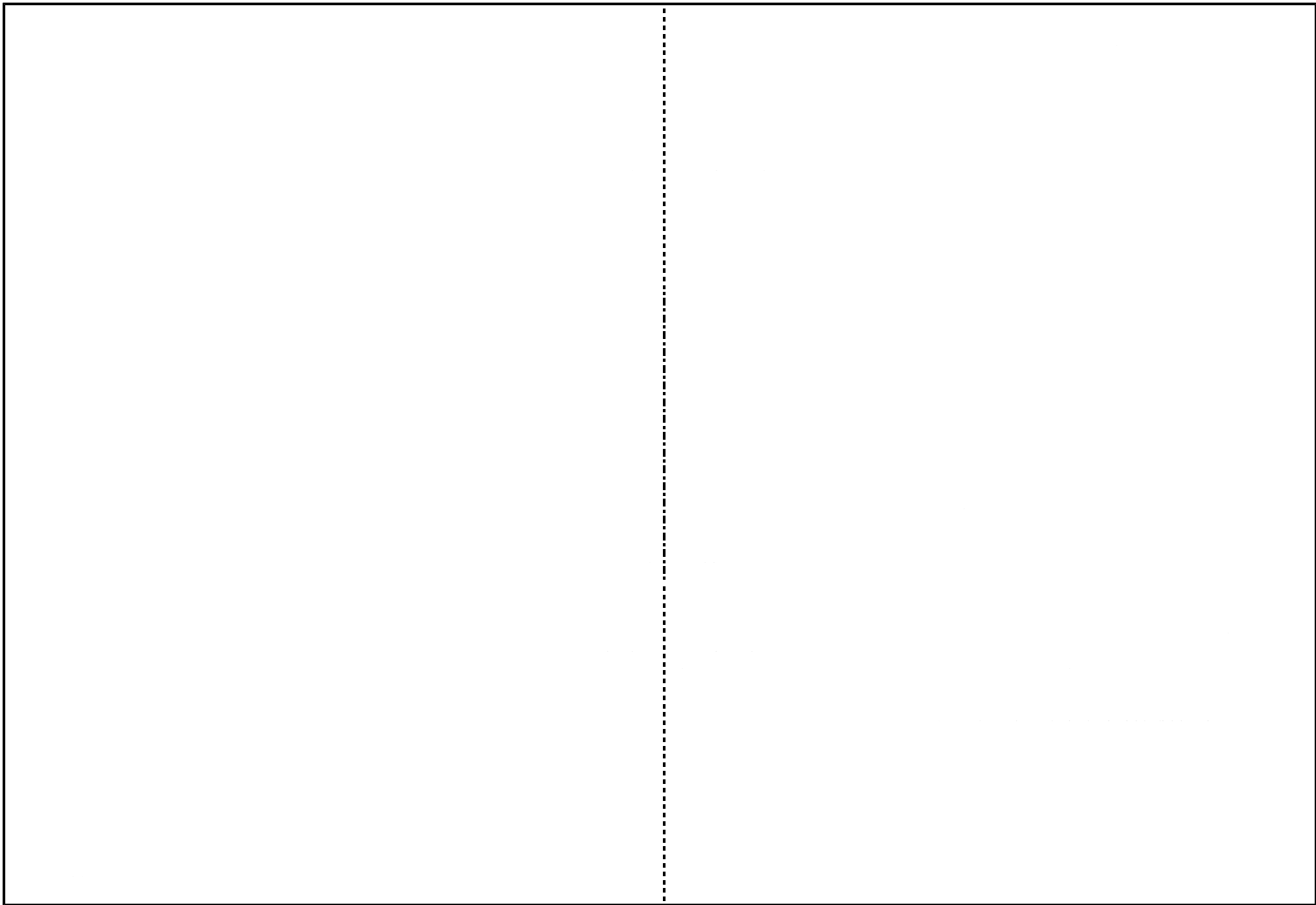

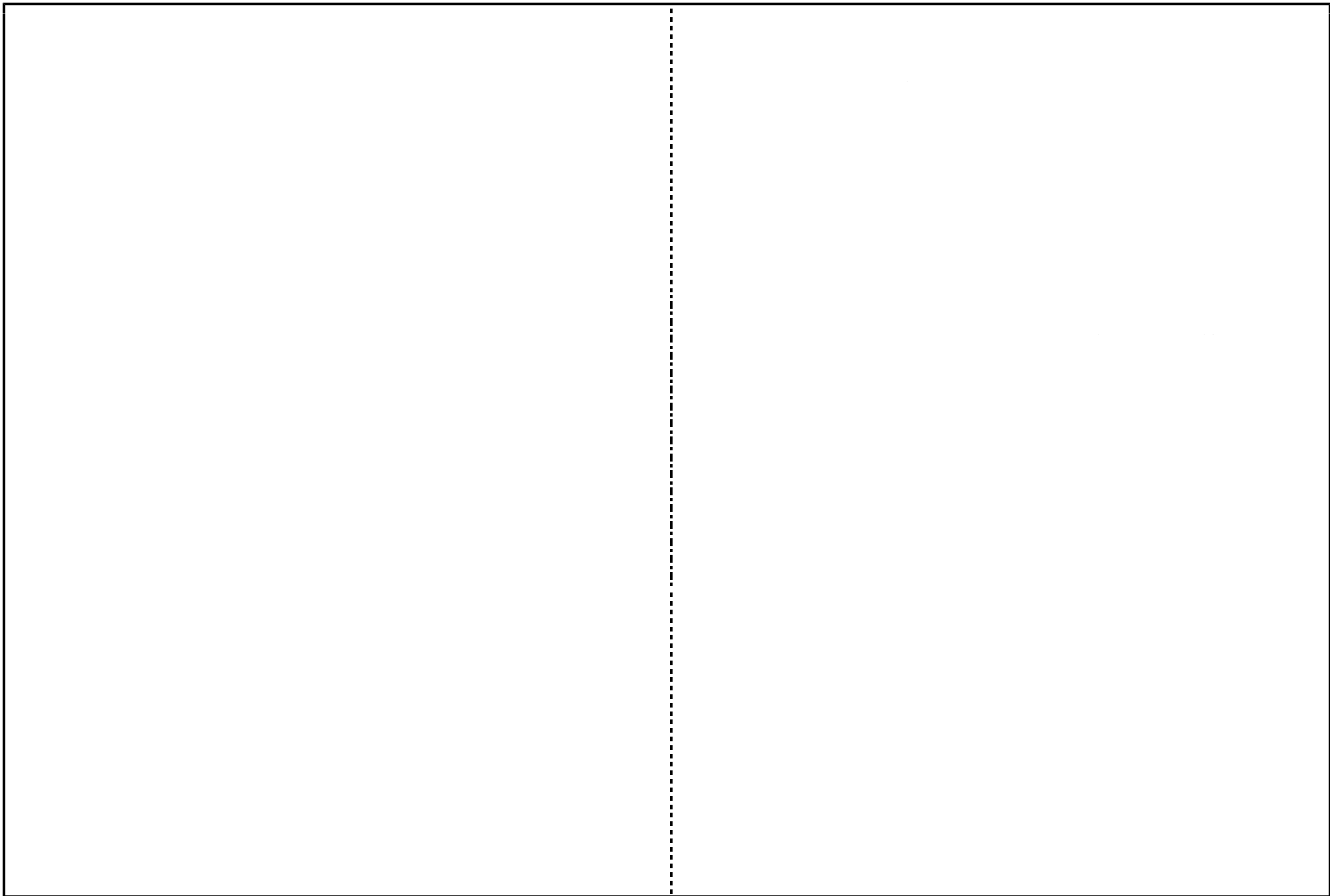

(1)

--

(1)

--

(1)

--	--

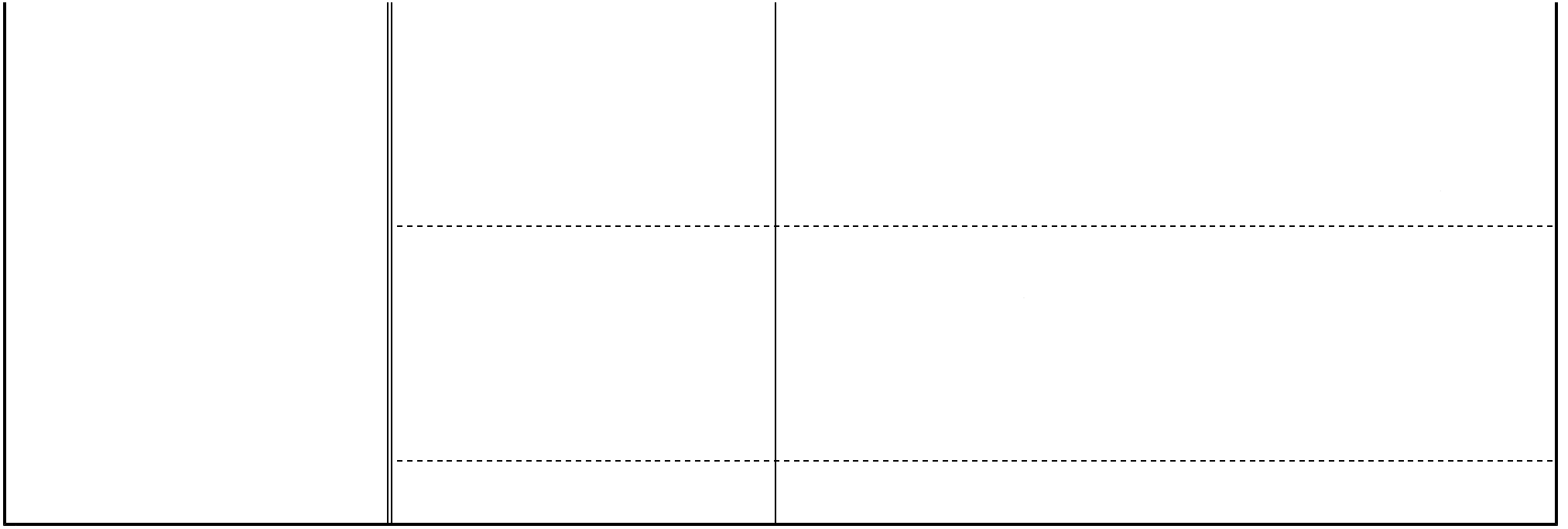

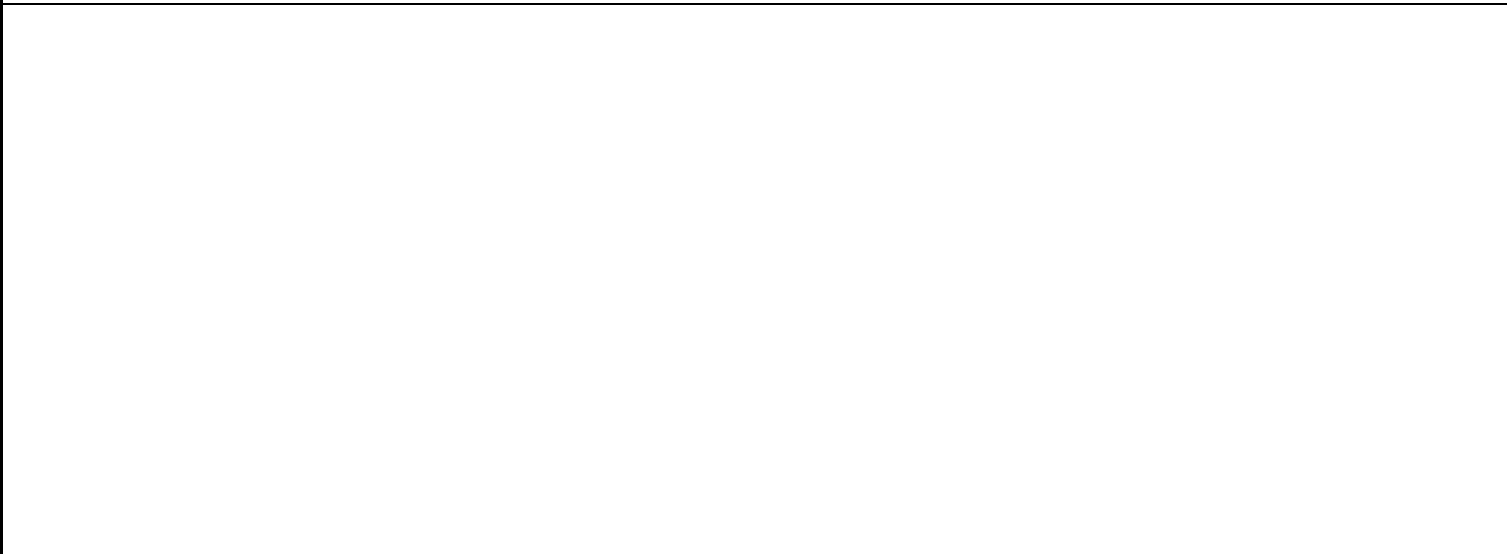
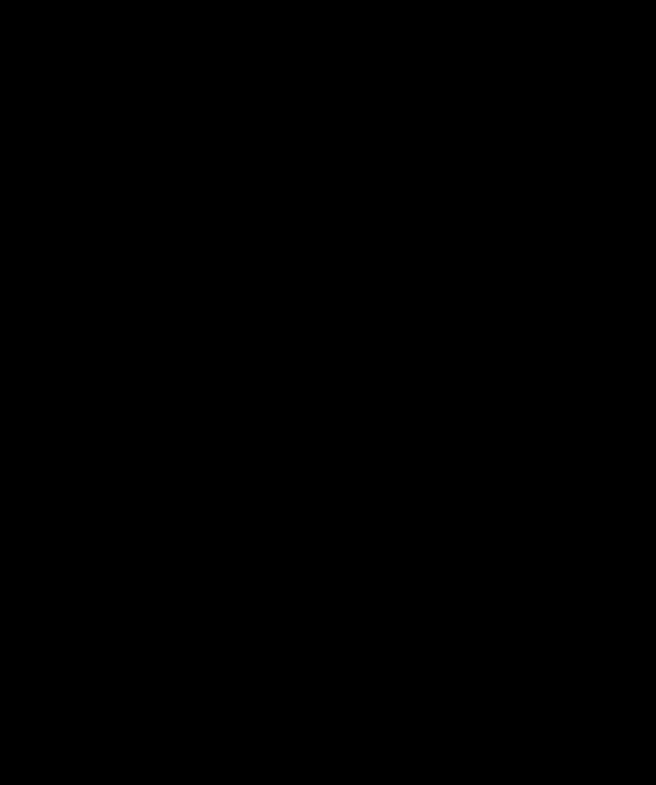

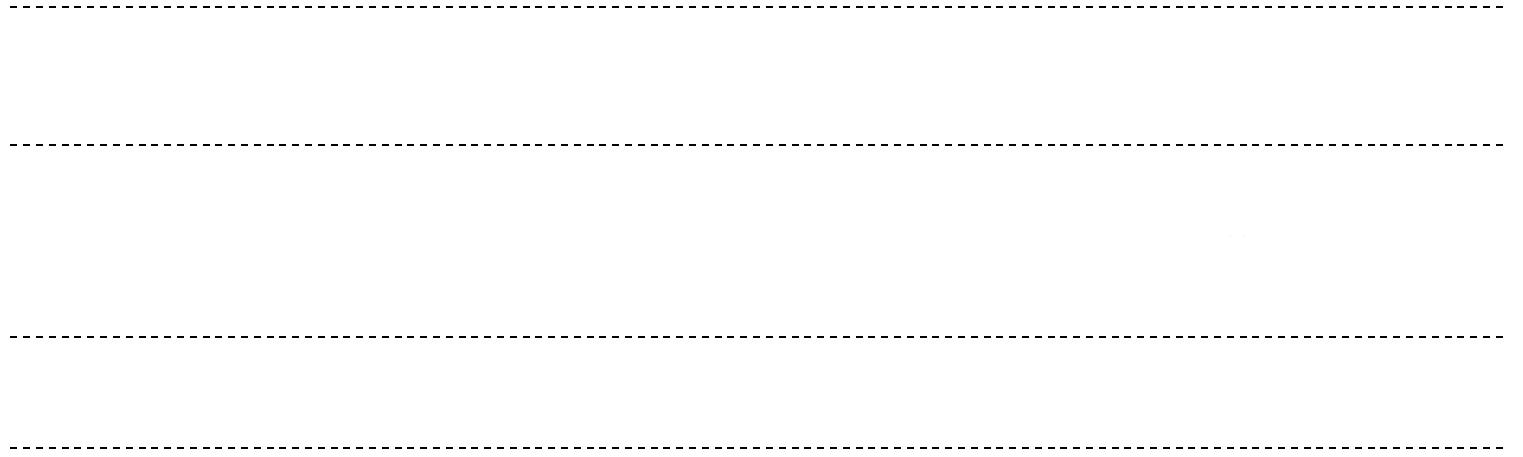

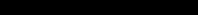

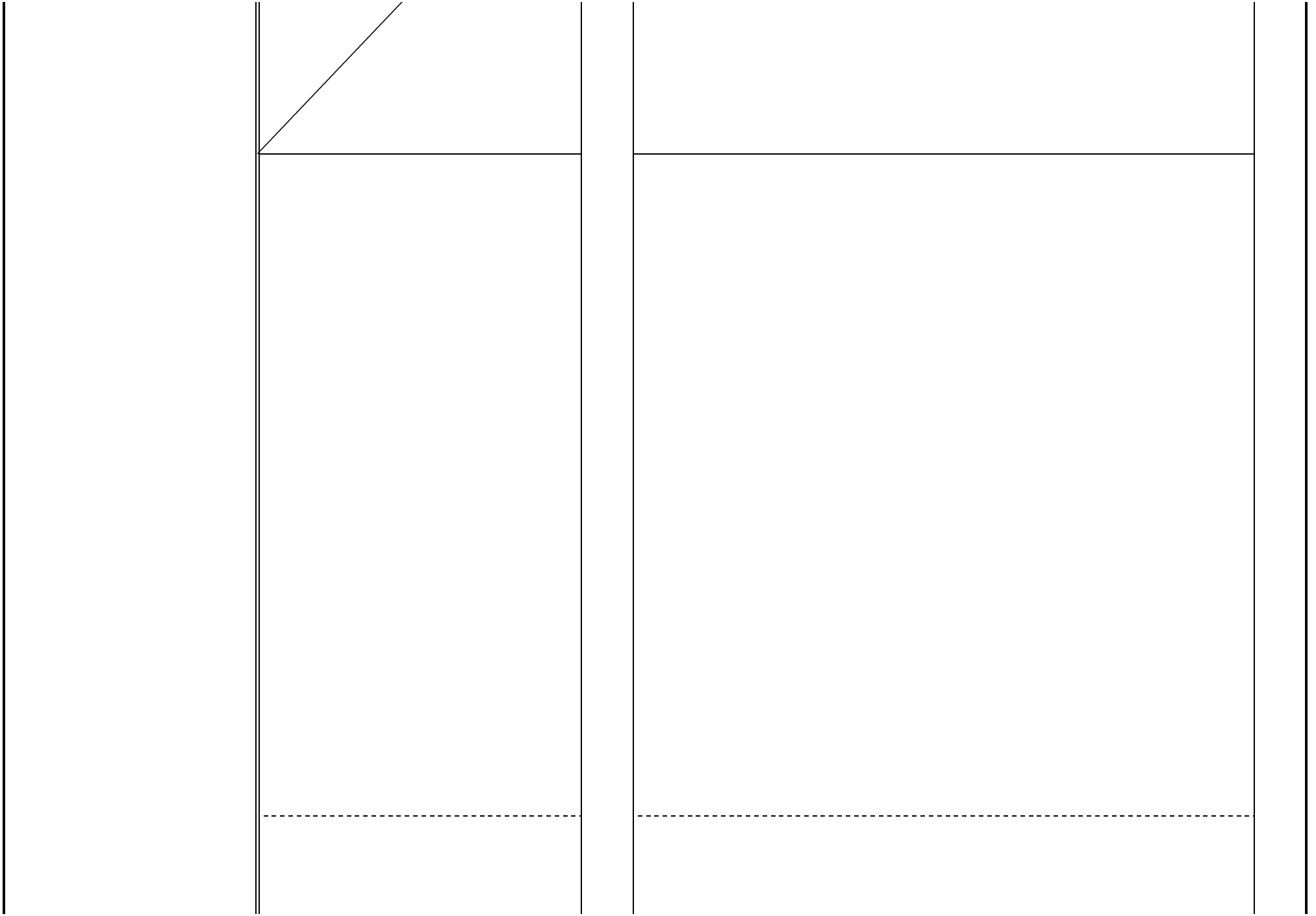

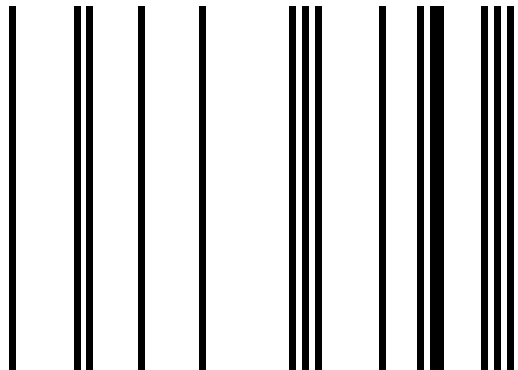

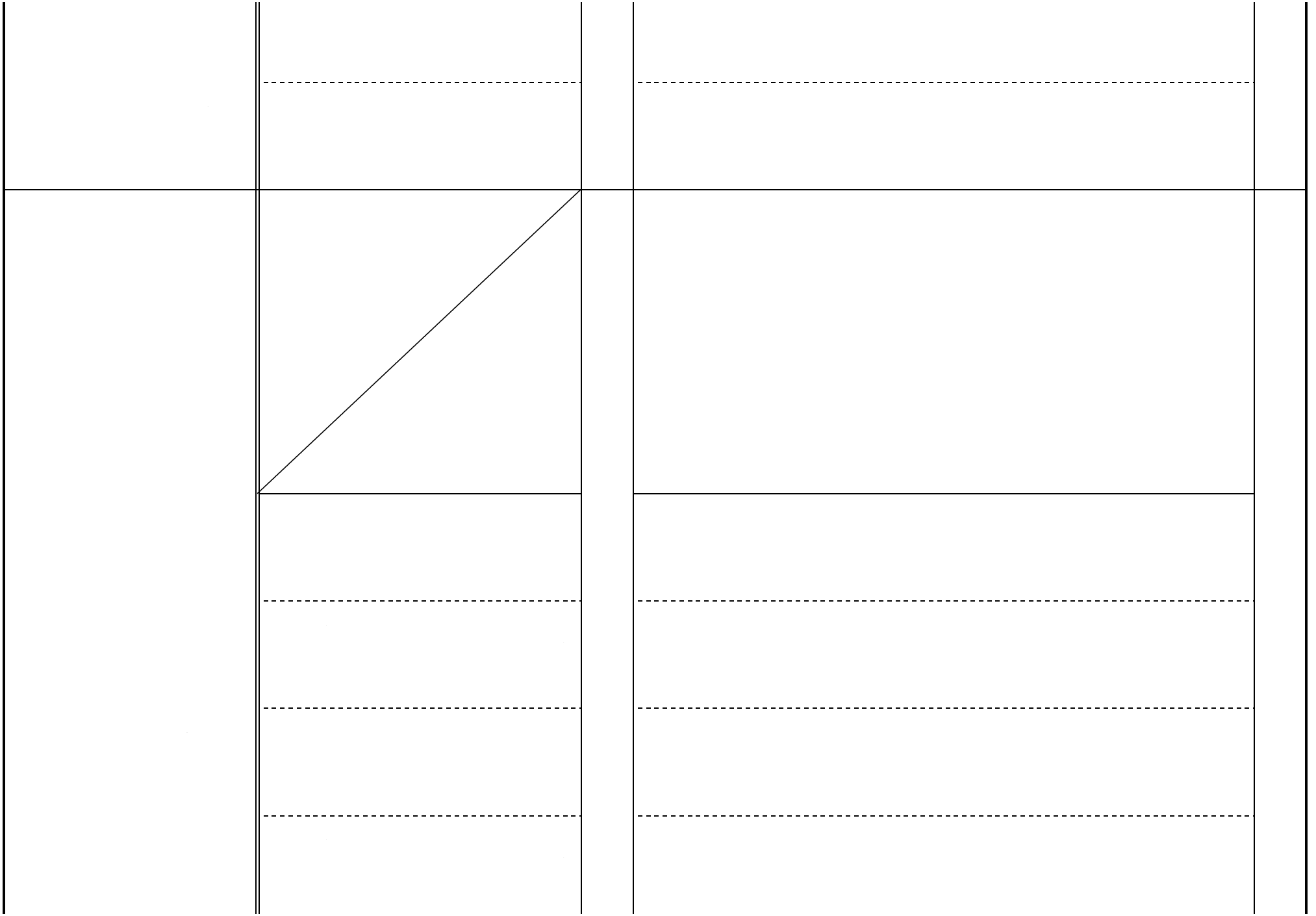

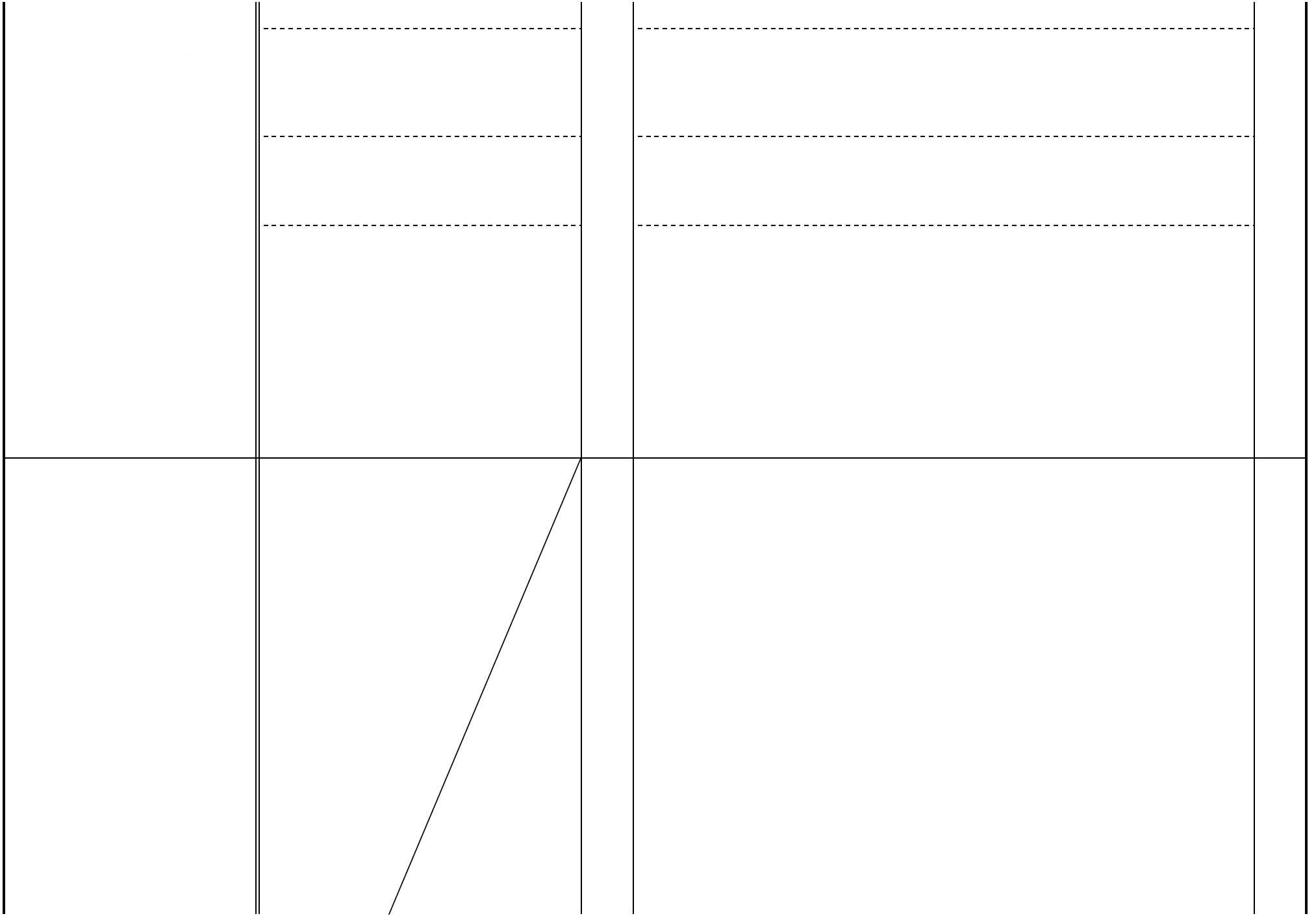

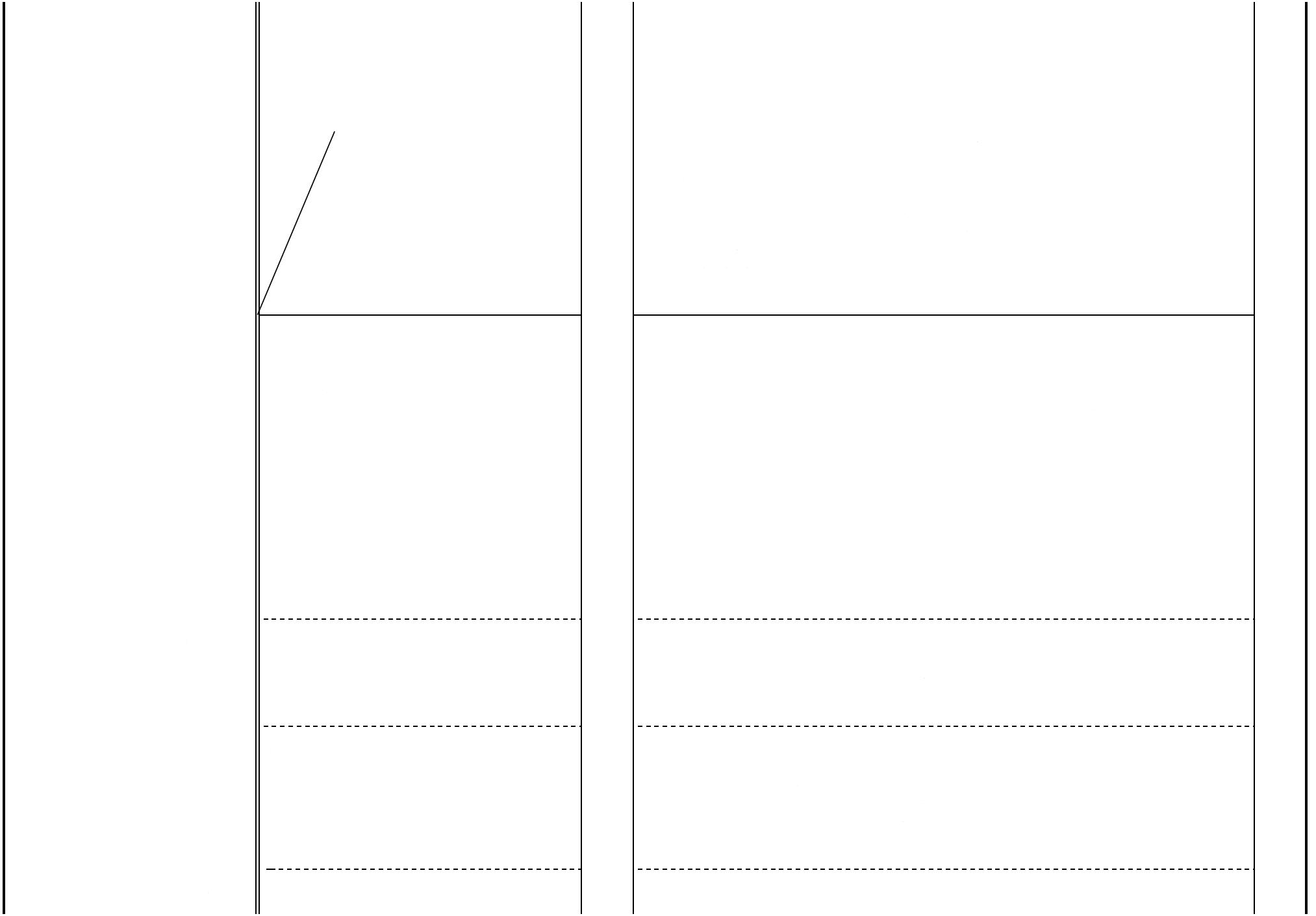



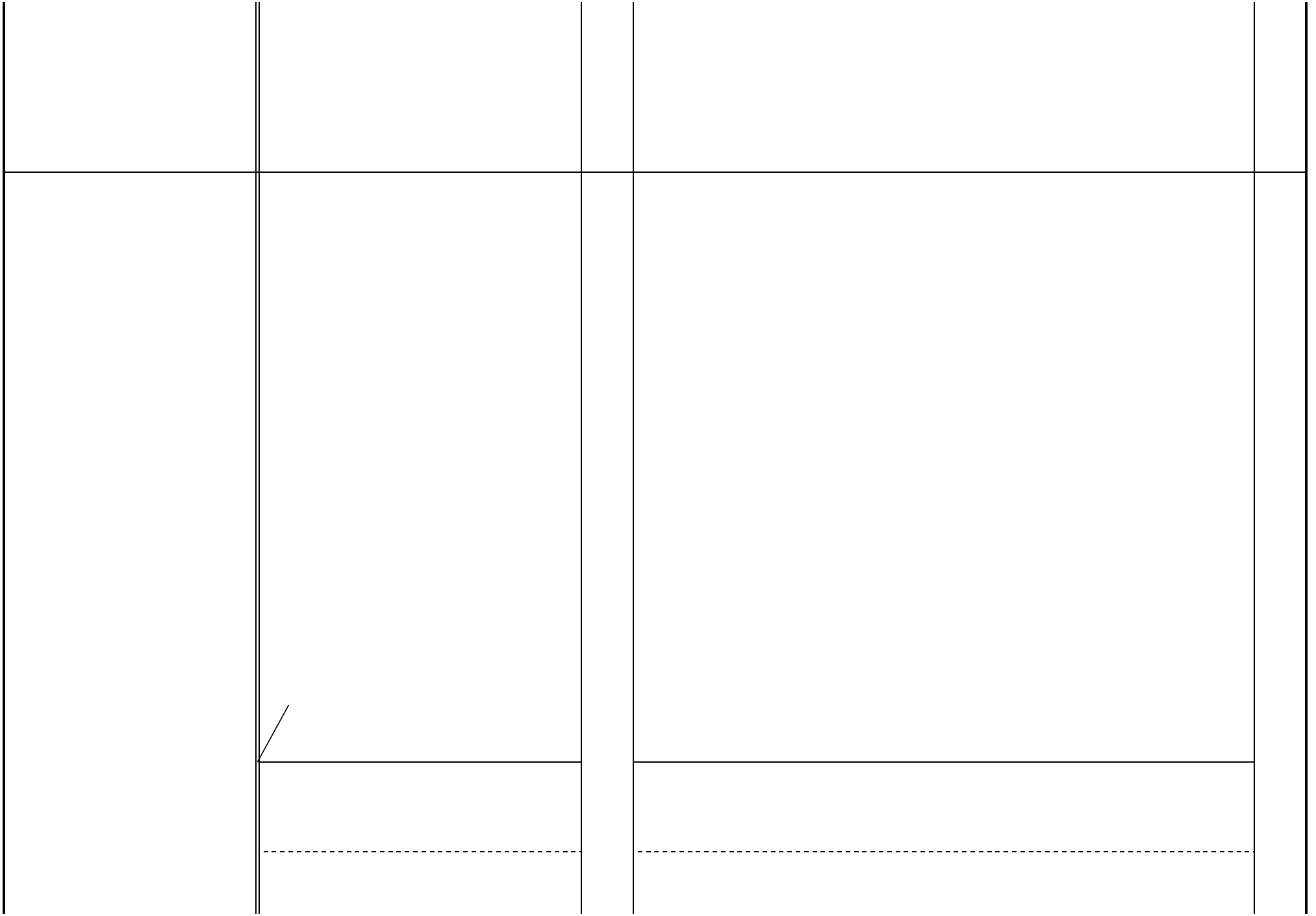

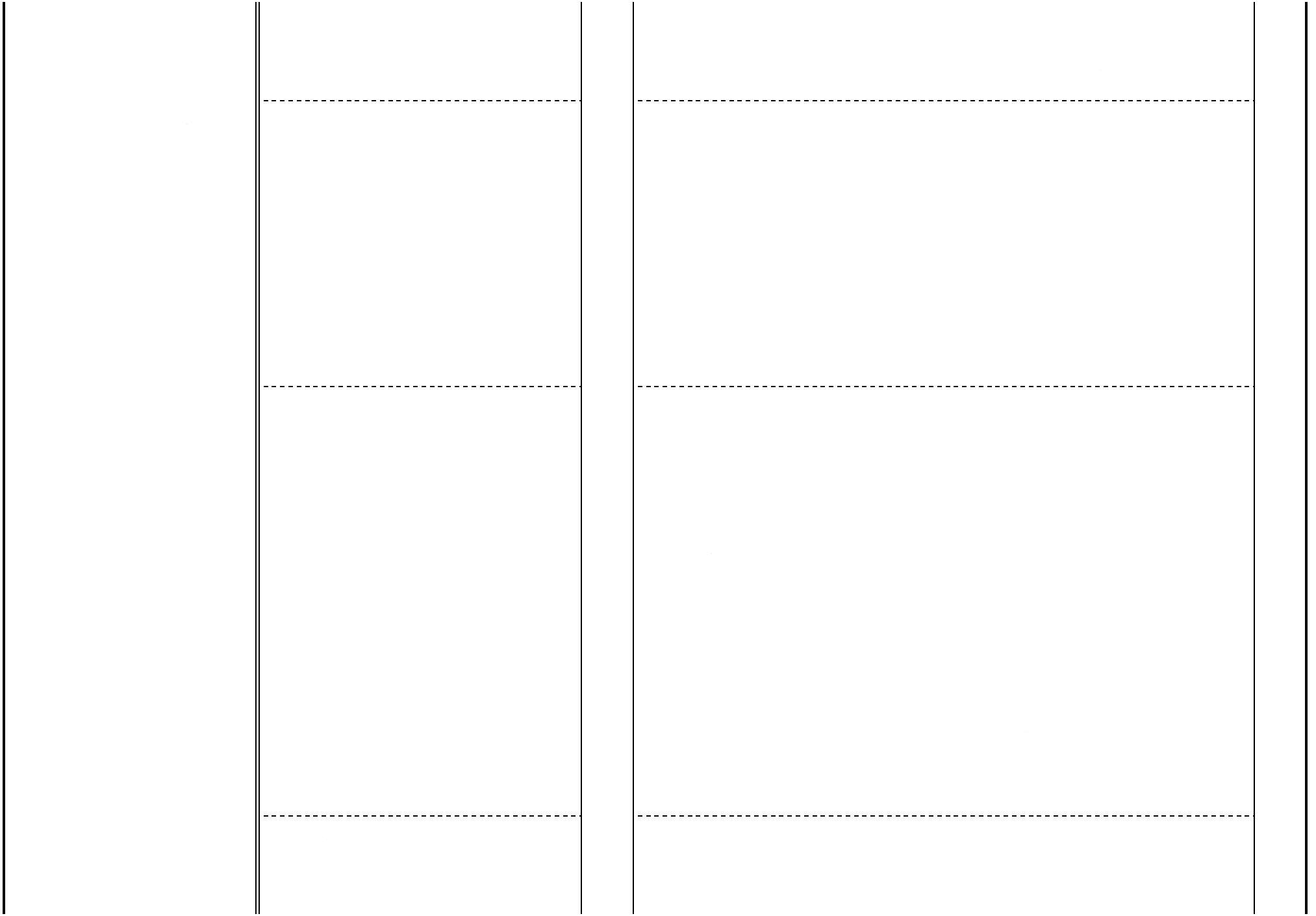

(3)

VÄ• 0đ™ic π1t /—0 π

-

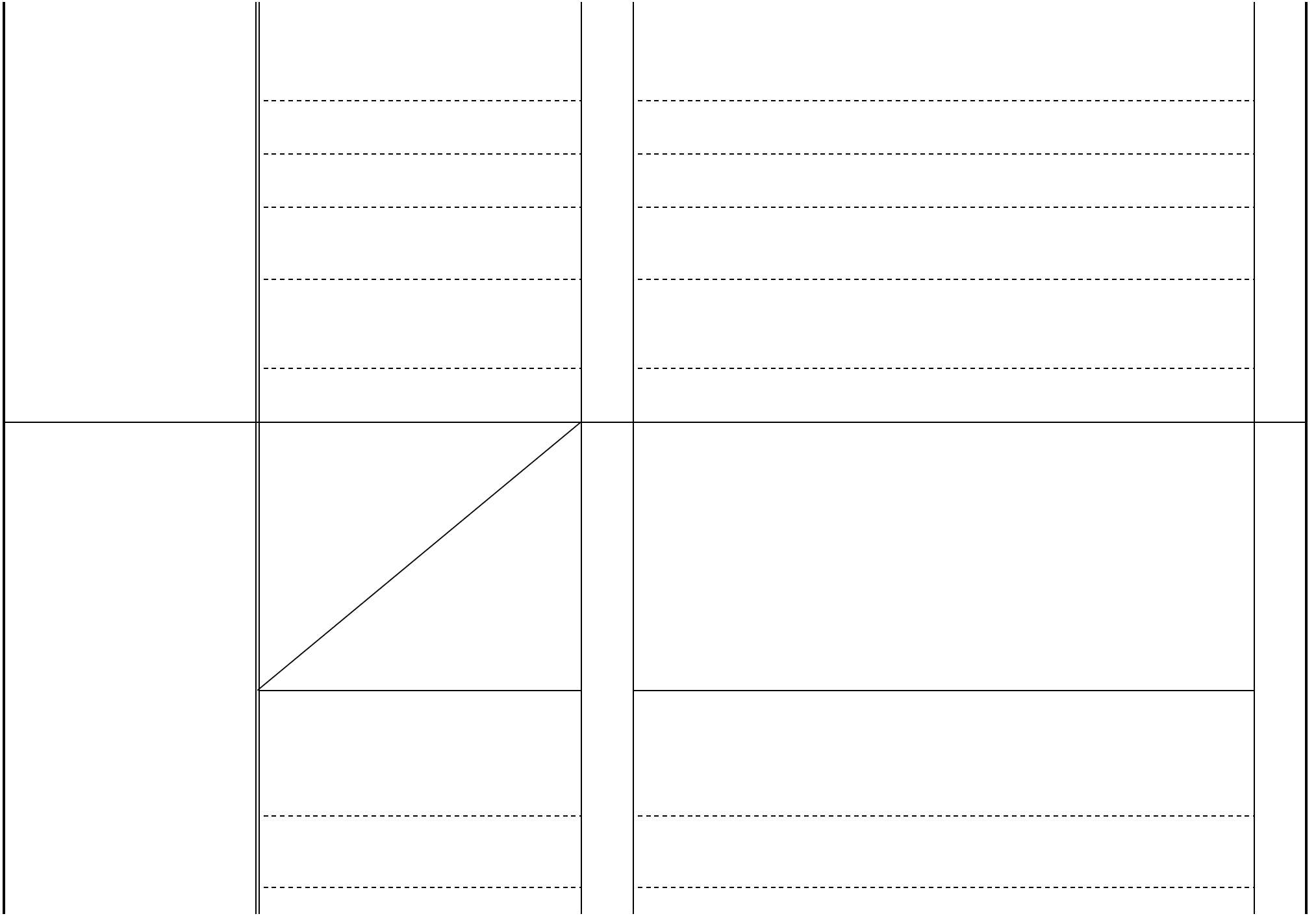

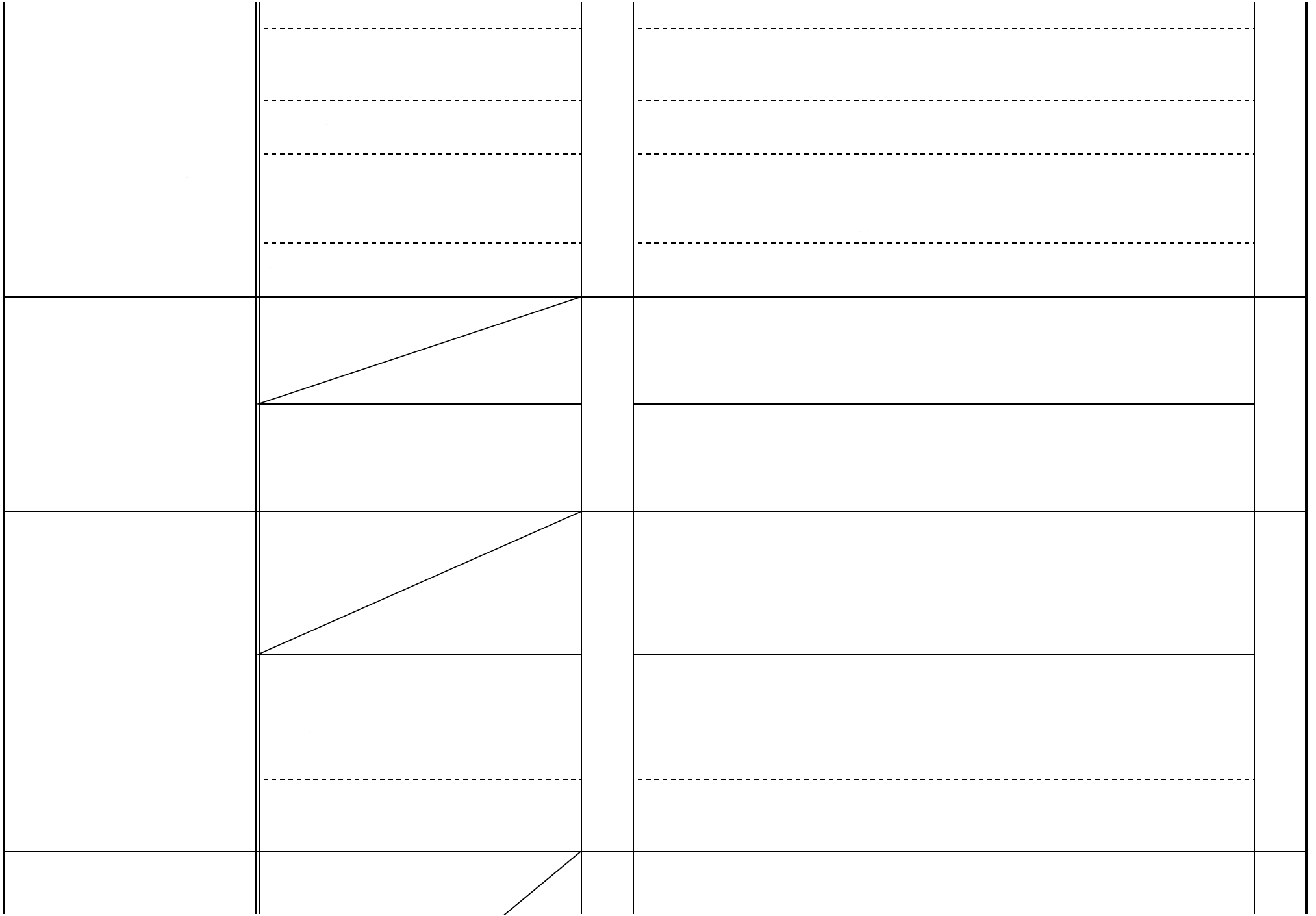

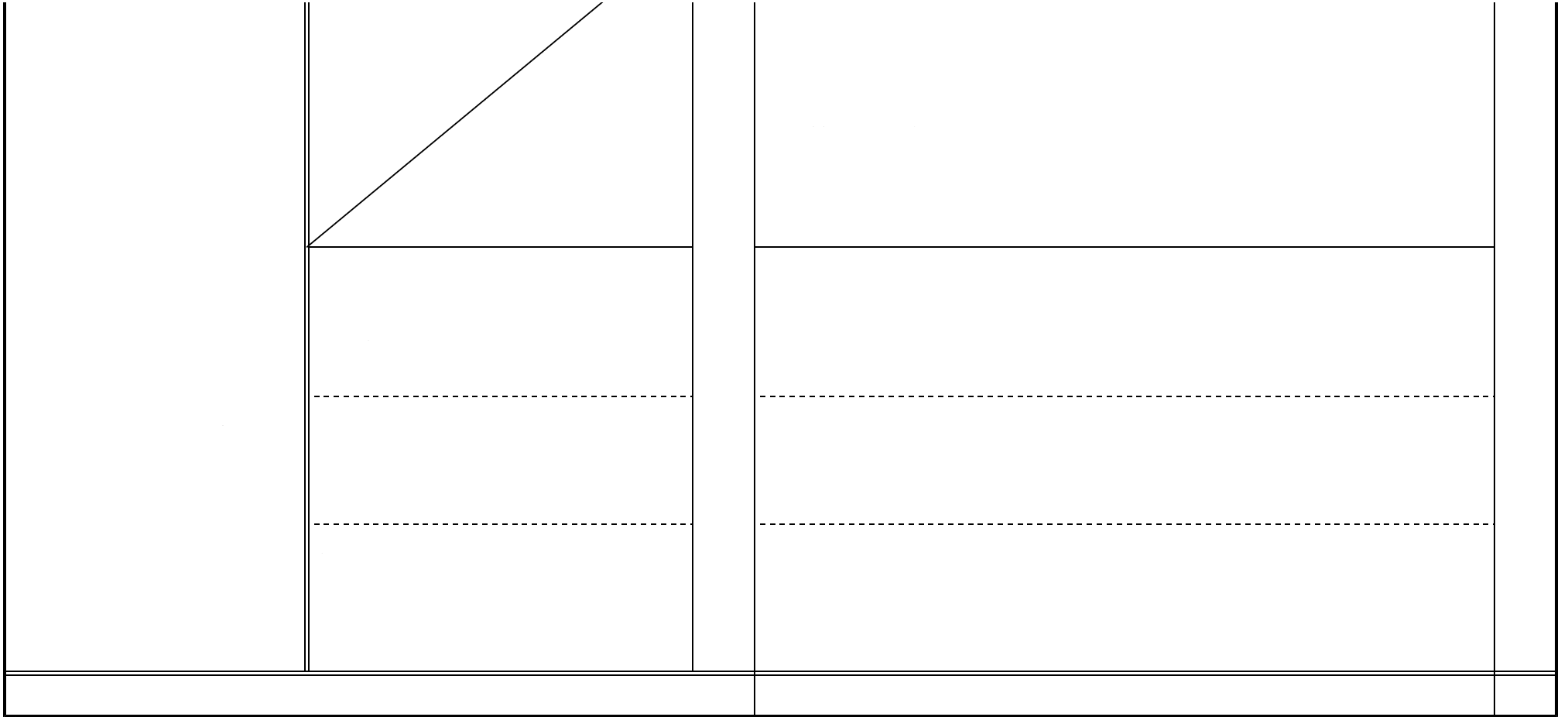

<hr/> <hr/>	

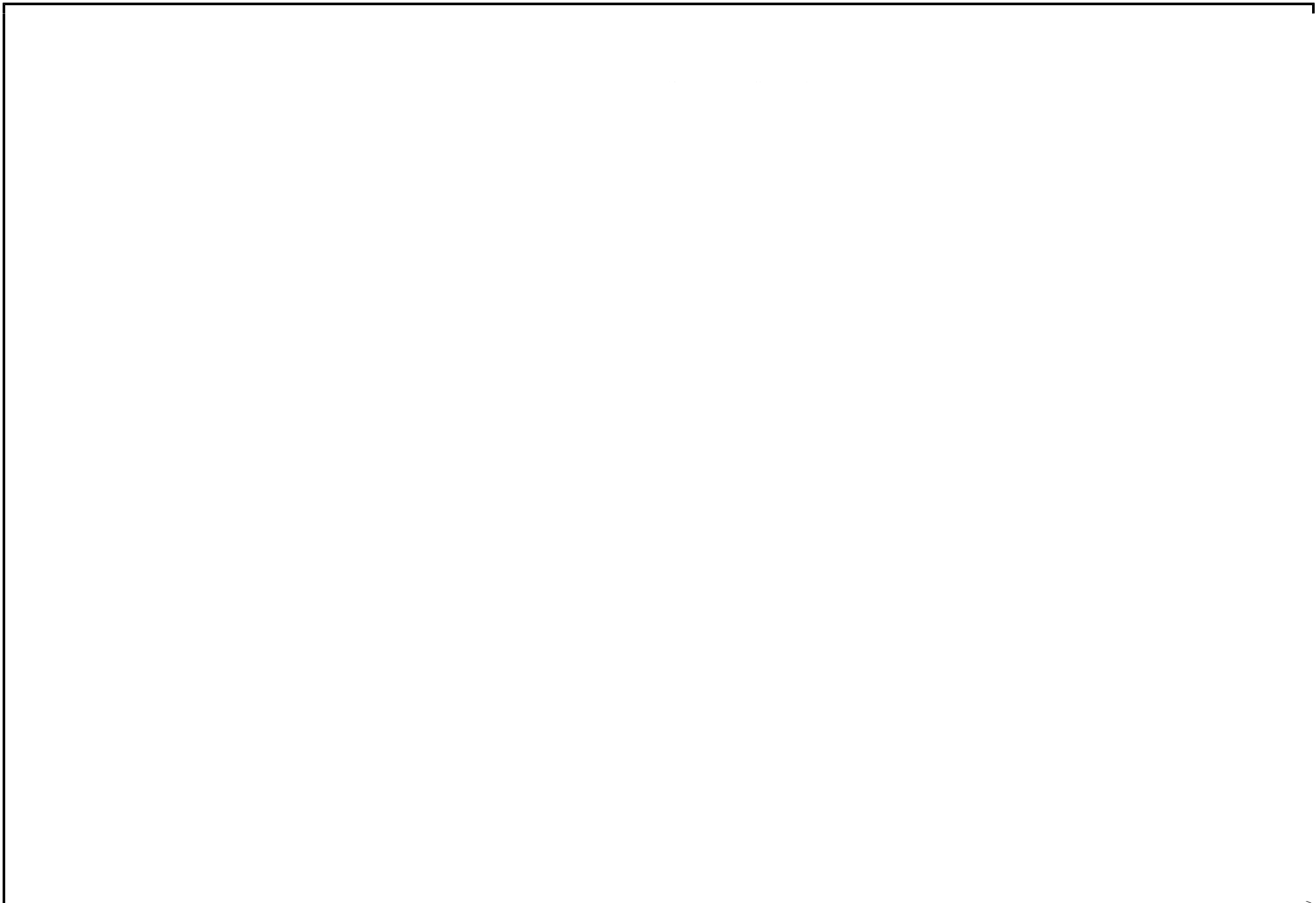



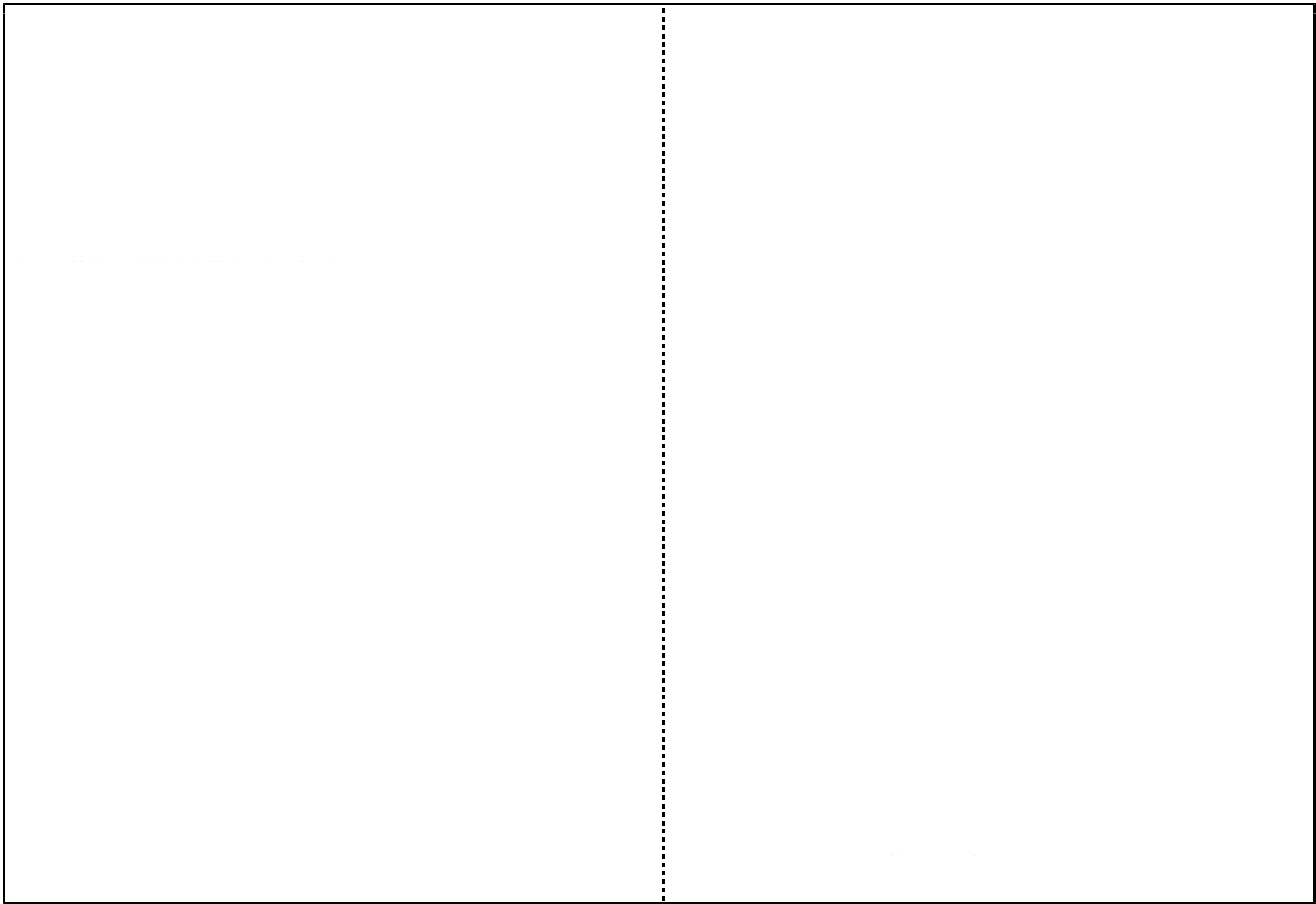

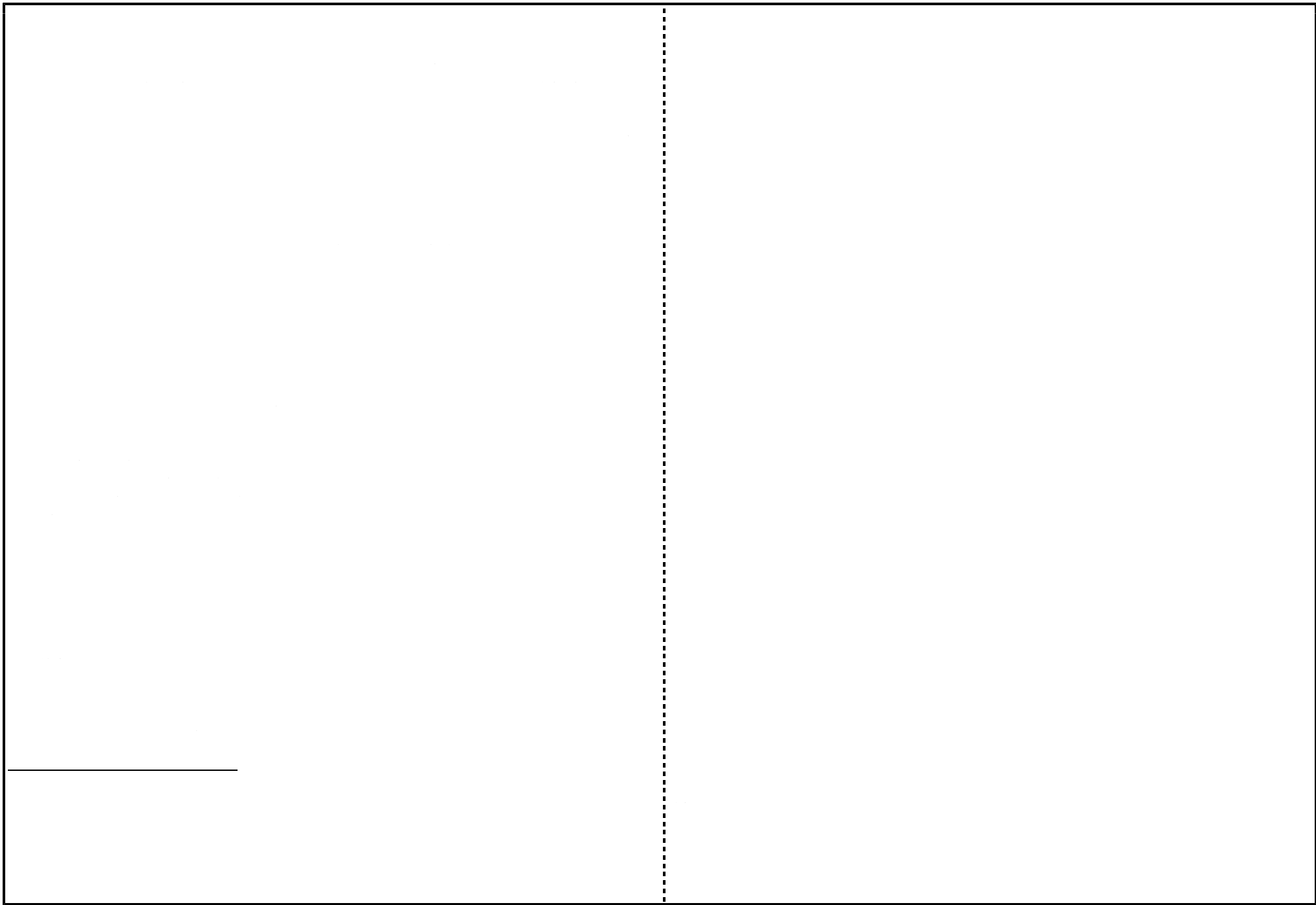

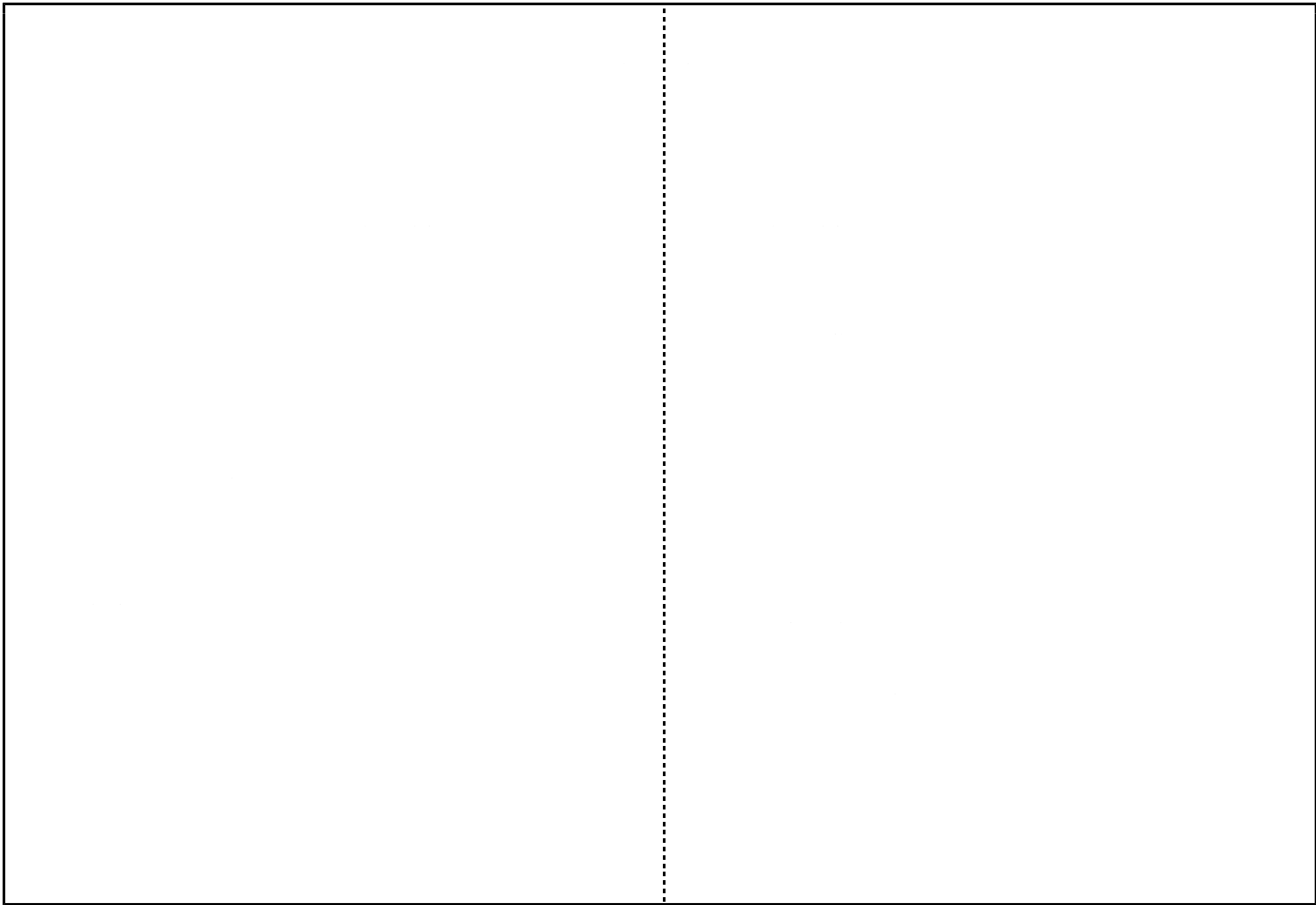

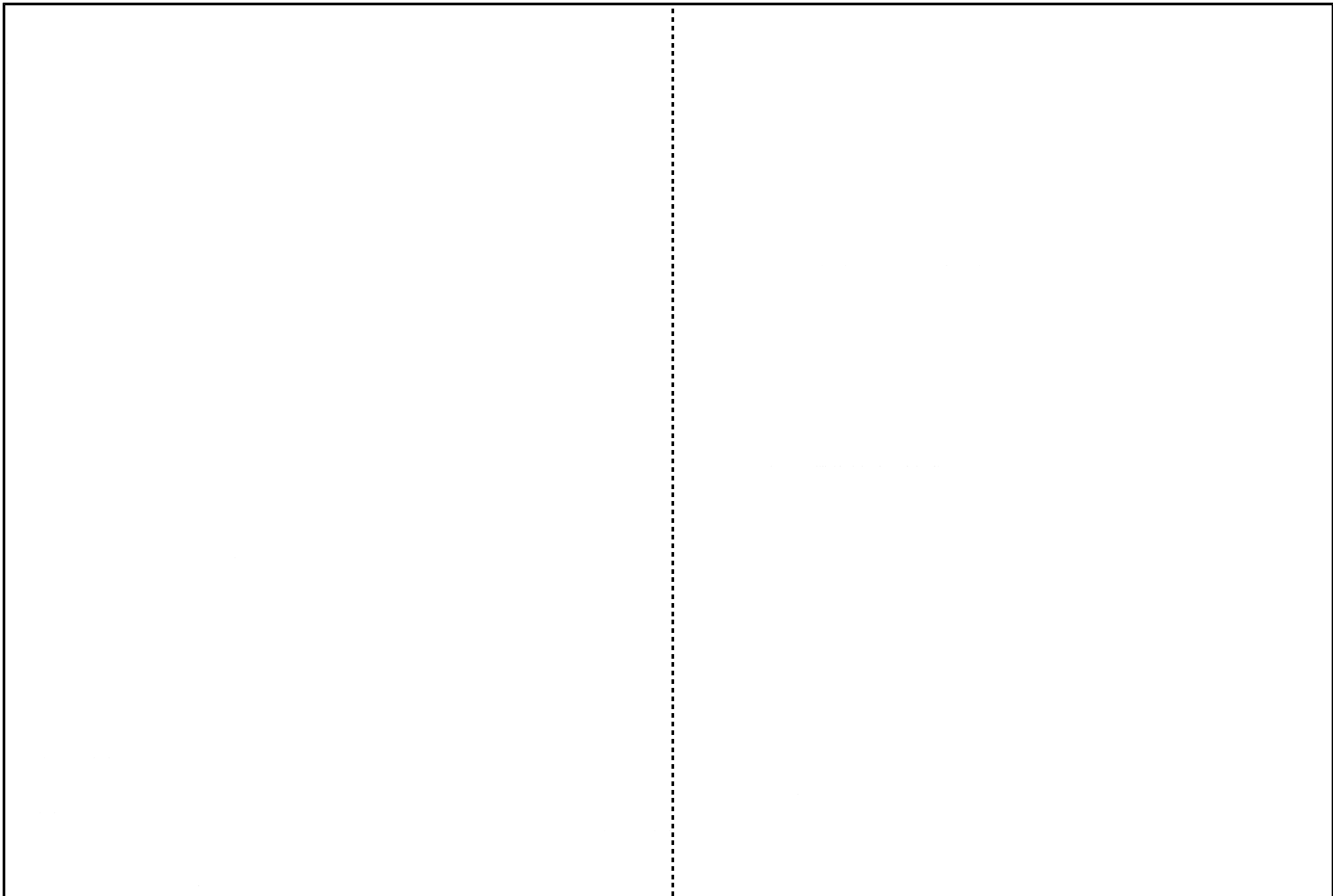



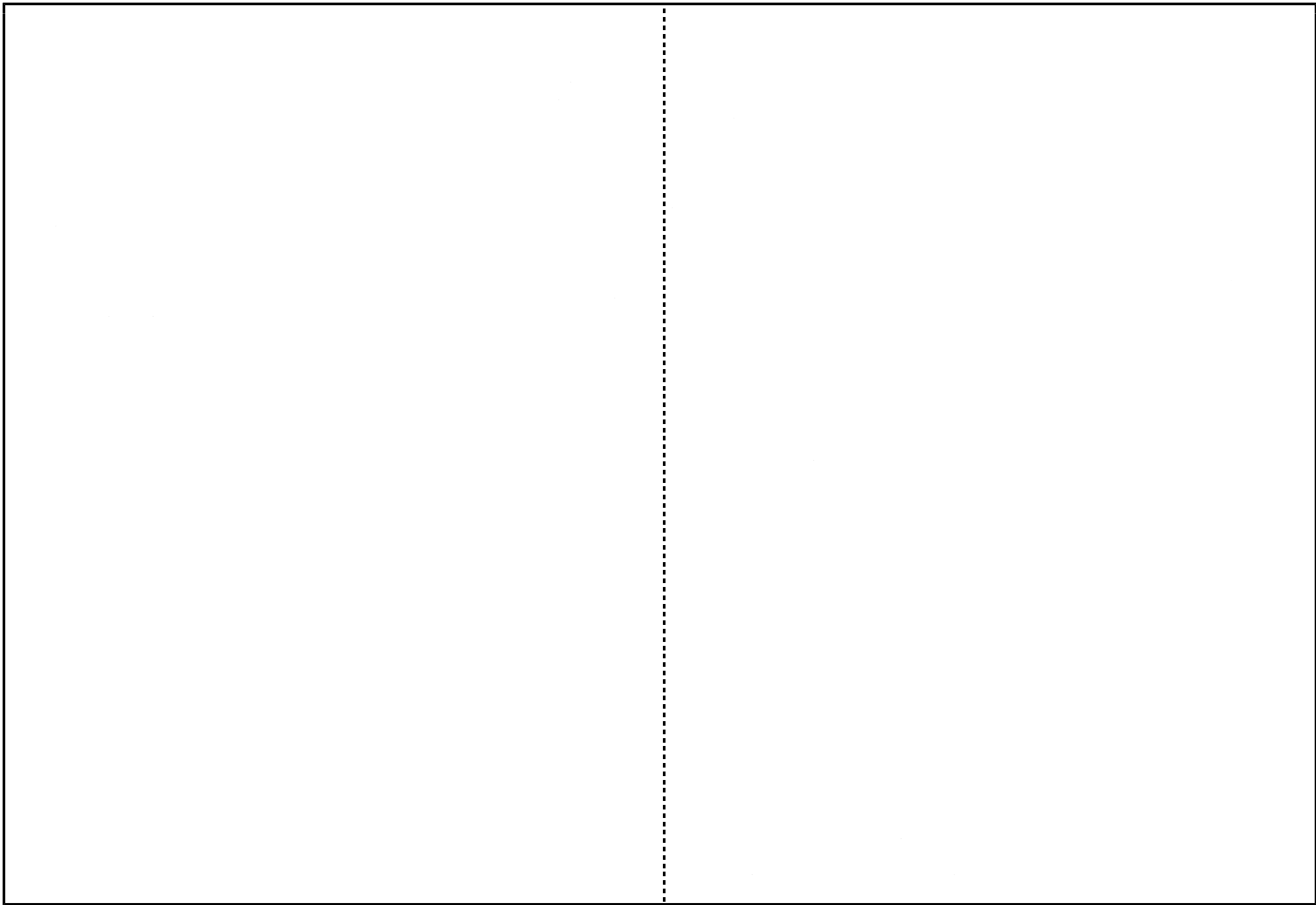

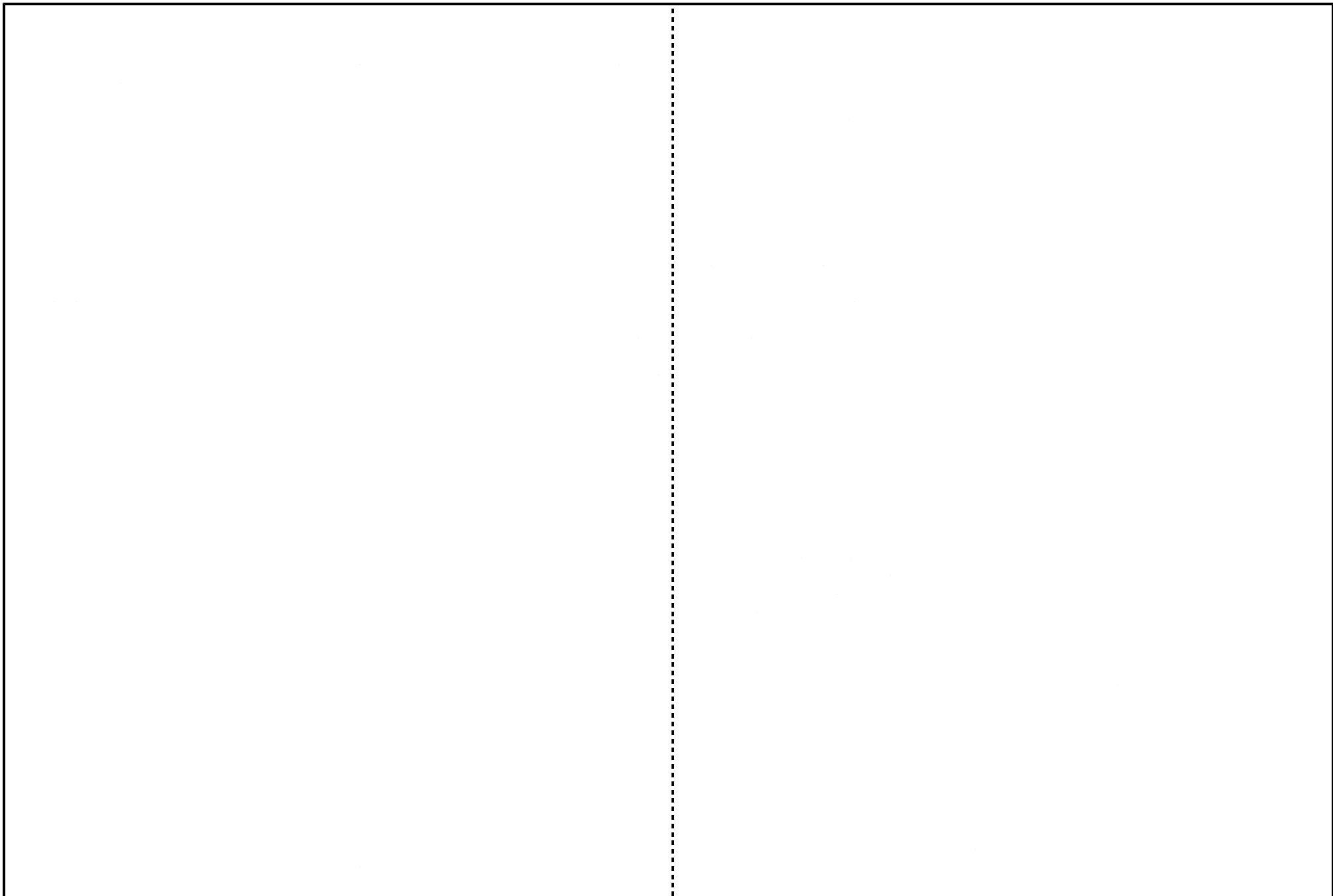

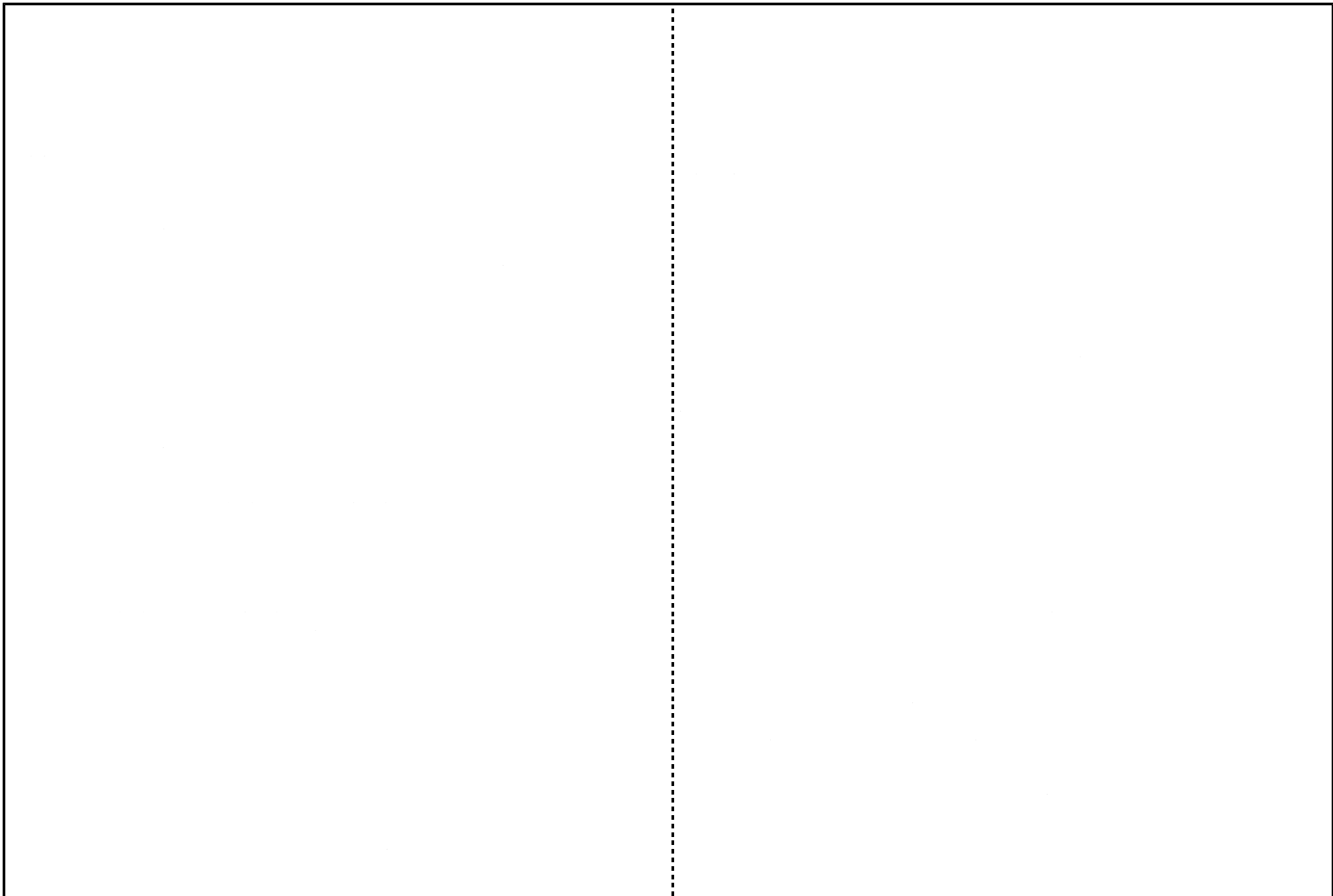

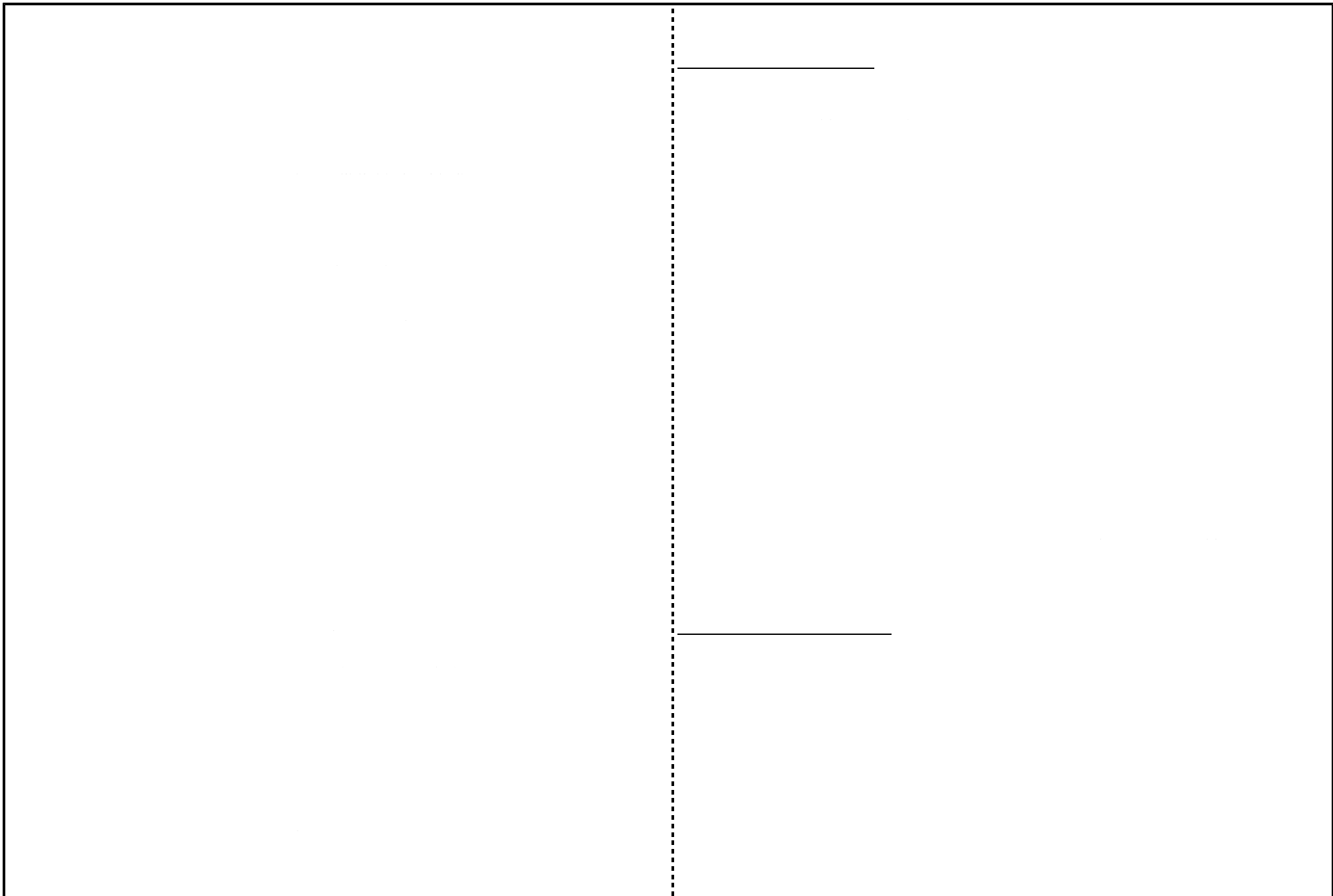

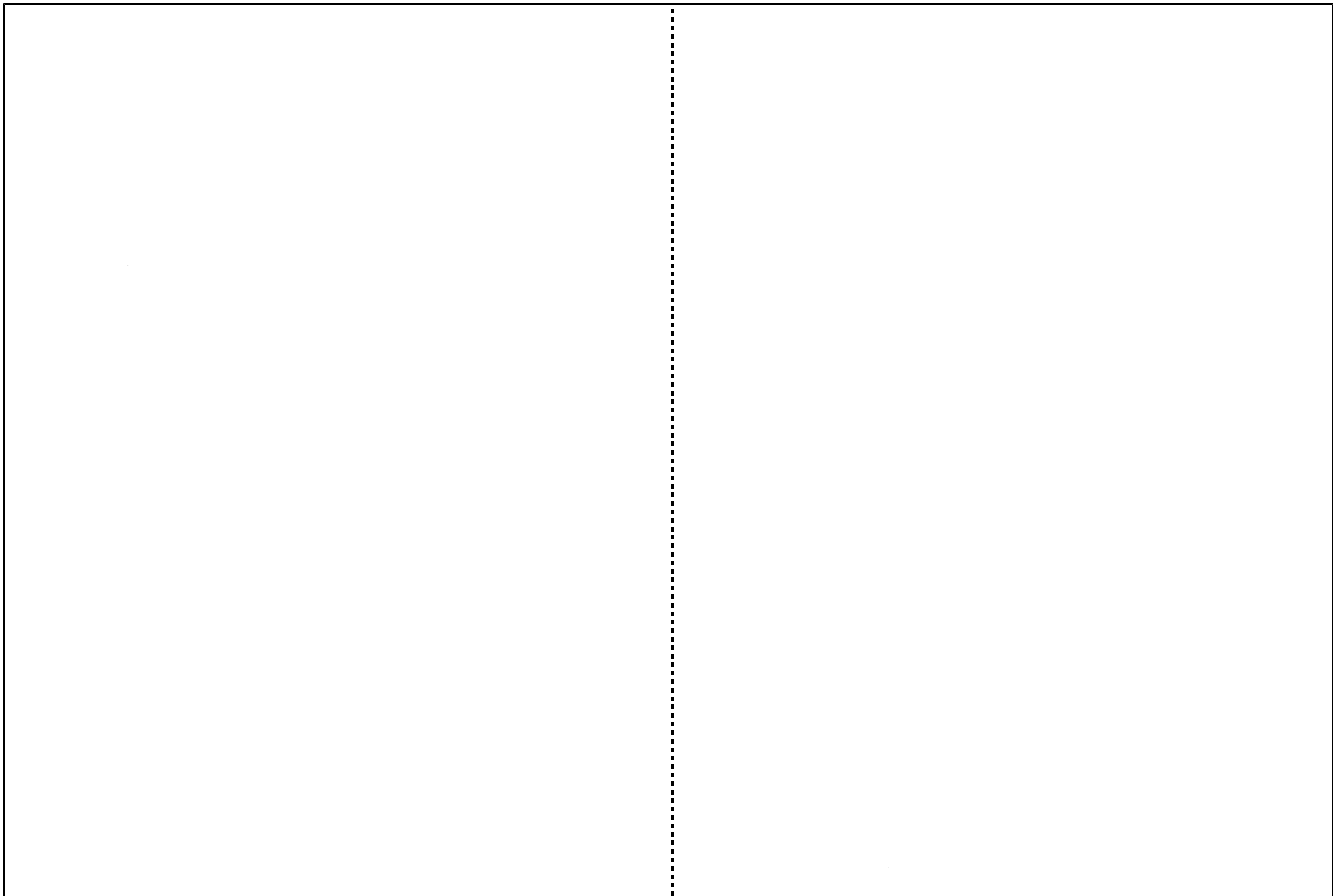

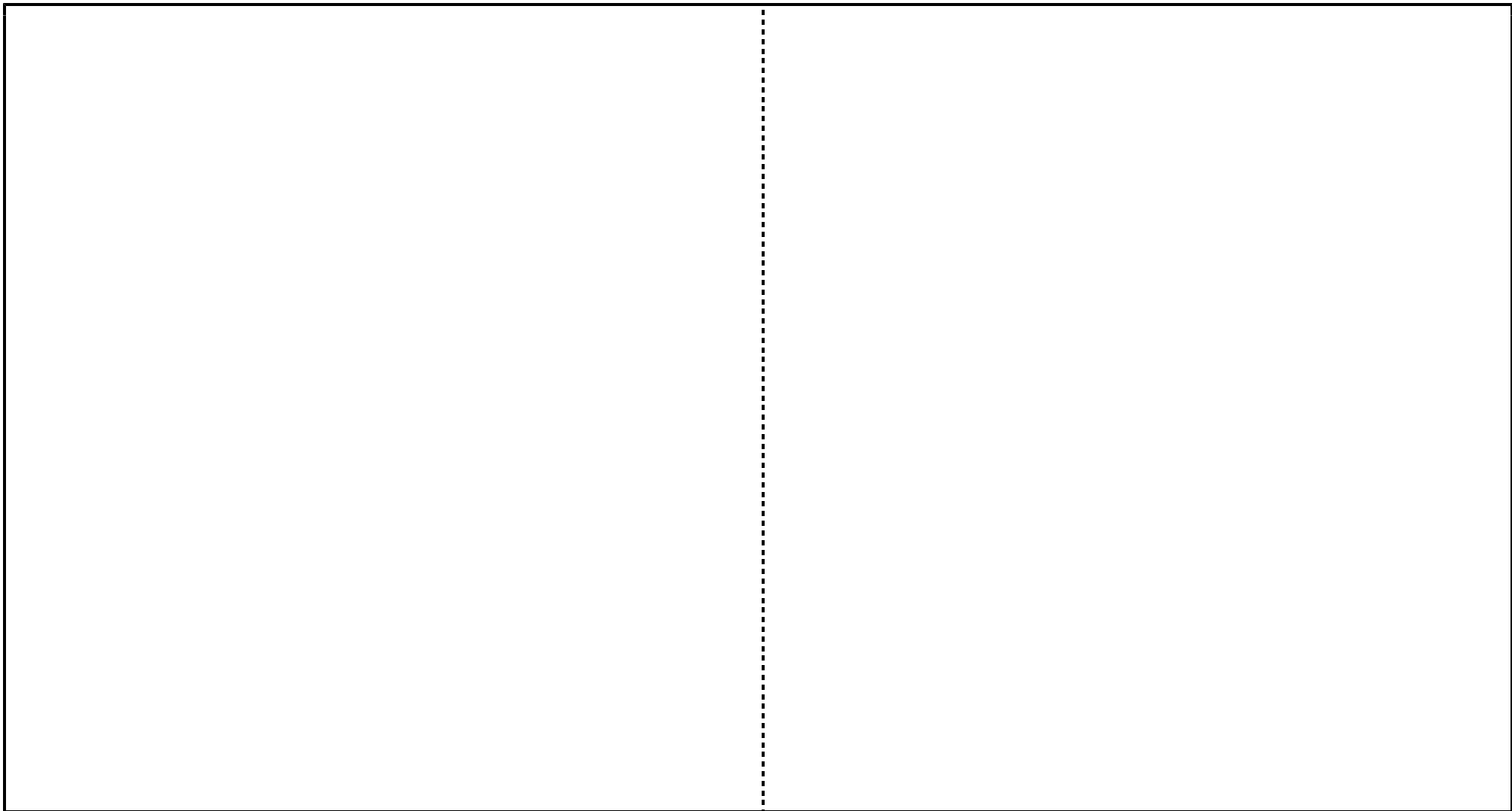

[Empty rectangular box]

[Empty rectangular box]

[Empty rectangular box]

[Empty rectangular box]



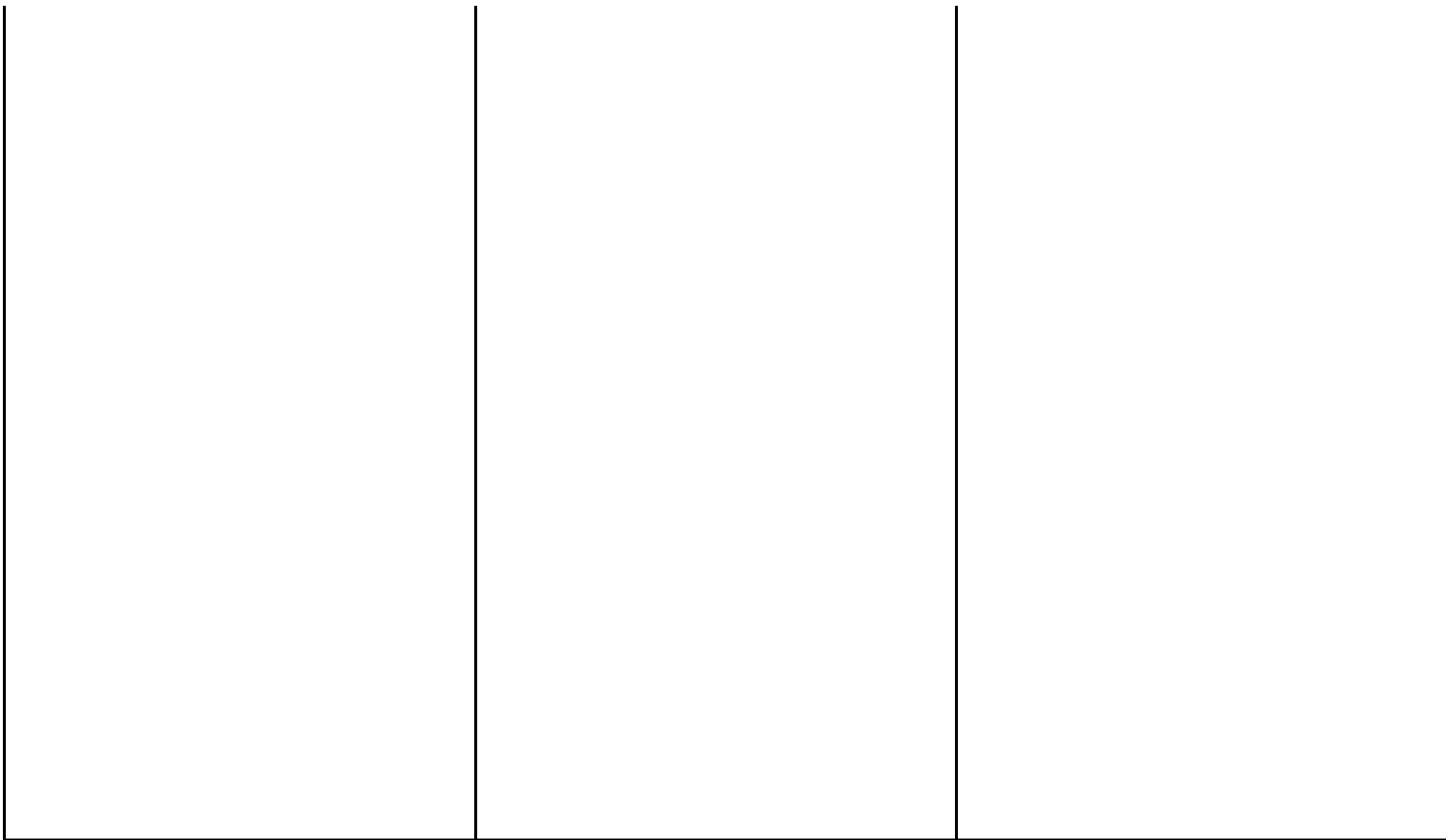

21. 5 1

	(a)	(b)	(b)/(a) x 100

	(a)	(b)	(b)/(a) x 100

	(a)	(b)	(b)/(a) x 100

	(a)	(b)	(b)/(a) x 100

	(a)	(b)	(b)/(a) x 100

()

()





Blank header box

